

London Overground Poster frame standard

Issue 2

Contents



Foreword

1	Standard poster frame sizes	5	Customer information poster site plans
2	Poster frame construction		For further information
2.1	Poster frame construction continued		
3	Leaflet racks		
4	Station poster requirements		
4.1	Station poster requirements - entrances		
4.2	Station poster requirements - ticket halls (entering)		
4.2.1	Station poster requirements - ticket halls (exiting)		
4.3	Station poster requirements - ticket halls (entry points)		
4.3.1	Station poster requirements - ticket halls (additional entry points)		
4.3.2	Station poster requirements at key decision points on platforms (and throughout the station)		



In conjunction with station signing, London Overground (LO) information posters and leaflets provide essential information to customers travelling on the network. We have always been regarded as world leaders in the display and development of such printed information, the Tube map having become a design icon, its style being emulated on rail networks worldwide.

To ensure that we maintain standards in the display of information posters, this document contains a schedule of poster sites required for generic station areas, which is summarised in section 5. Each station is periodically scored for the display of fixed information.

The provision of information poster frames is the responsibility of LOROL but any maintenance required must be reported by station management.

The provision of customer information should always take priority over the siting of commercial elements such as advertising.

It is intended that LOROL will, in the future bring all the stations up to standard. This section outlines the types of posters and frames required on stations, and the purpose of the various poster types to ensure that the customer information needs are understood and reflected during the planning process. As the posters are posted and regularly updated by station staff, it is essential that the TfL poster plans for each station are kept up to date to reflect the current status.

I Standard poster frame sizes

The sizes indicated are based around the standard Transport for London (TfL) poster frame construction as detailed on the next page. Where other constructions are used, at heritage stations for example, sizes must be checked with TfL Signs Unit to ensure the correct fitting of posters.

Frames should be fitted such that the top edges are 2 metres from floor or pavement level to ensure consistent alignment and legibility. This dimension may only be varied under approval from TfL. Frames must be fitted vertically, and should only be recessed with adequate space around the frame to allow for access to fit, maintain and open. A minimum gap of 40mm must exist between frames to allow frames to be opened using the standard key.

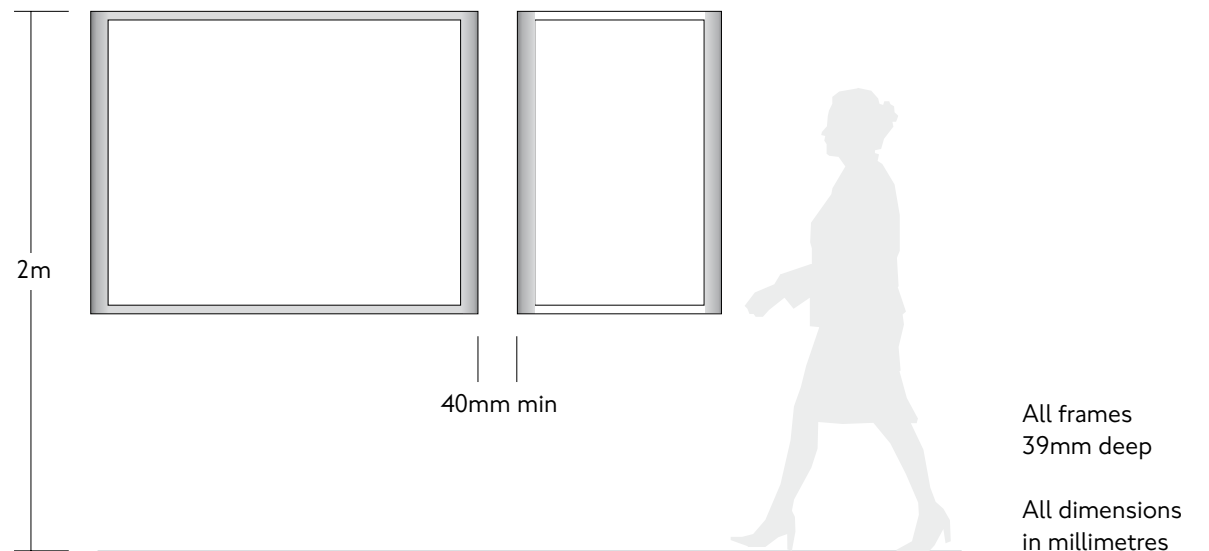
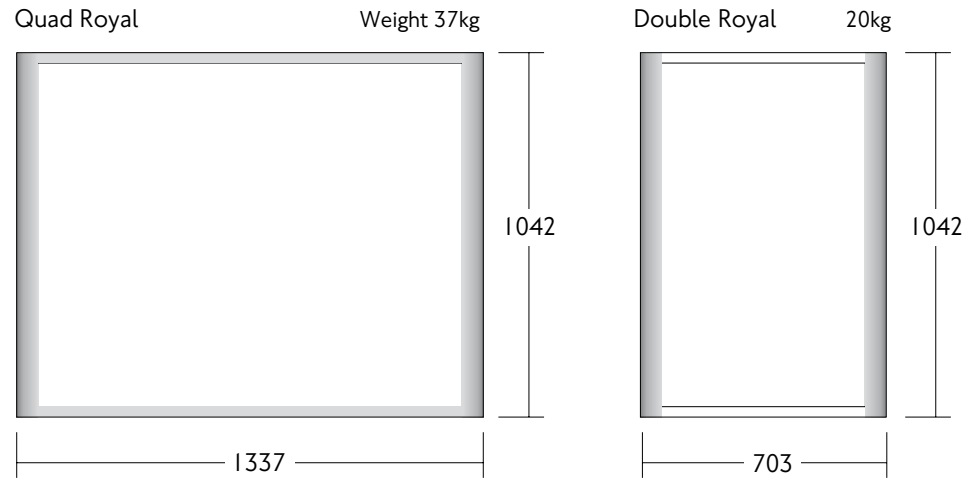

2 Poster frame construction

At the time of taking over the stations LO found that there was a great variety of poster frame constructions already installed, too many to detail all here. However two of these types are shown as examples in images 2 and 3.

These must be updated as part of any station improvement project. Eventually all frames should be of the standard TfL type (image 1), unless instructions have been issued by LO or TfL for heritage or other specific reasons.

Standard TfL poster frame



1



2

Old SMF frame:
Square edges
all round



3

Aluframe:
Square edges
with hinged
leaves (one open
in photo)

2.1 Poster frame construction continued

Contents



The standard construction and operation of TfL frames is vital to ensure that posters can be easily and safely changed at scheduled periods by station staff without special tools.

The standard frames have modern clean lines with curved sides to be safe for customers when moving in crowded station environments. These are available in silver as the standard finish, with a bronze finish version available for heritage sites where specified by LO.

- 1 Hinged aluminium extrusions
- 2 4mm safety glass
- 3 Concealed fixings between sections

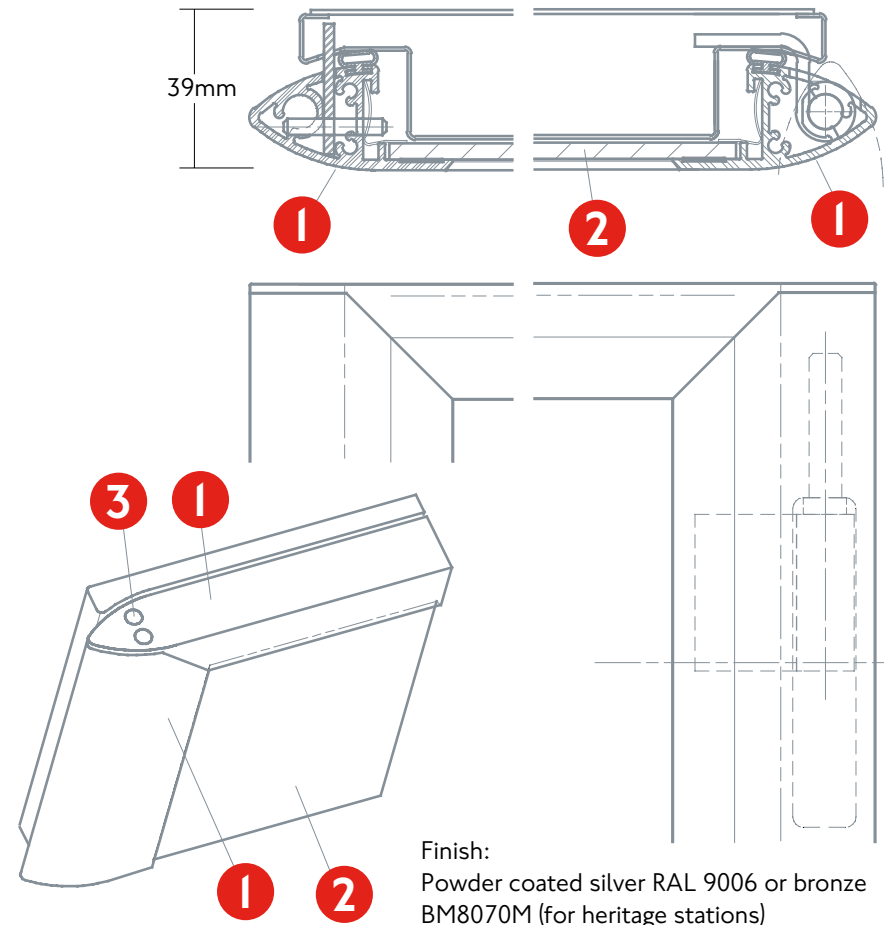
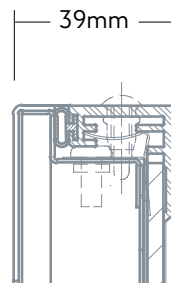

Finish:
Powder coated silver RAL 9006 or bronze
BM8070M (for heritage stations)

3 Leaflet racks

At present any leaflet racks currently on the stations are to be utilised. In time they will be changed over to the TfL standard leaflet rack (as shown here) integrated into the standard TfL poster frame.

These racks are based around a standard cast aluminium divider unit, which has no base ensuring litter cannot clog the unit when temporarily empty.

- 1 Standard Double Royal leaflet rack and frame
- 2 Leaflet rack detail

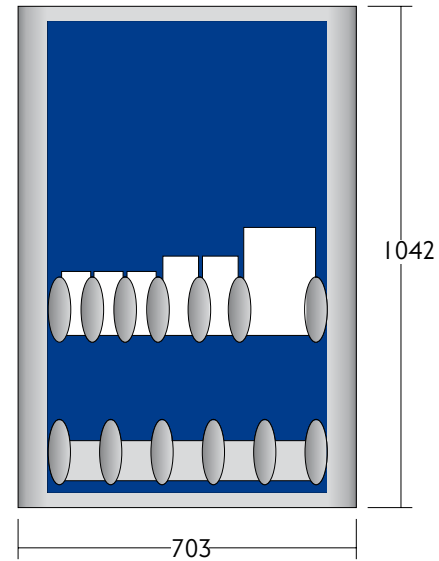

1



2

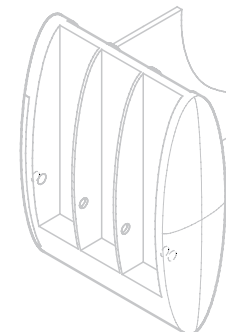

4 Station poster requirements



The following pages provide guidance as to the correct quantities and positions of information poster frames required in typical station areas. Whilst the requirement is generic, the different station layouts will require careful planning to ensure the optimum arrangement is achieved.

Where possible the frames should be coherently grouped, without cramming sites between other elements. This will ensure that the information is easily located by the customer, and that there is minimal confusion between LO information and commercial advertising. Care must also be taken to ensure that frame positions do not cause congestion, and on no account should information poster frames be fitted over stairways or seats.

Detailed plans should be developed for each site in consultation with TfL information planners, to ensure compliance with standards, and that the correct posters are delivered and posted both during and after the improvement project.

Free standing unit

If there is insufficient wall space to fit the specified quantity of information poster frames in any area of the station, a freestanding unit should be fitted. Standard frames should be utilised at the correct height, and the unit must be in accordance with TfL design and construction standards. Care must be taken to ensure the unit does not cause unnecessary congestion.



4.1 Station poster requirements - entrances

Contents



All frames outside stations must be positioned as close as possible to the entrance, and be clearly visible when the station is closed.

If there is insufficient wall space, a freestanding unit should be fitted.

The minimum requirements for poster frames outside a station are as follows:

A London connections map - Quad Royal

B Timetable - Quad Royal

Note that if space allows, additional circuit poster frames are to be added

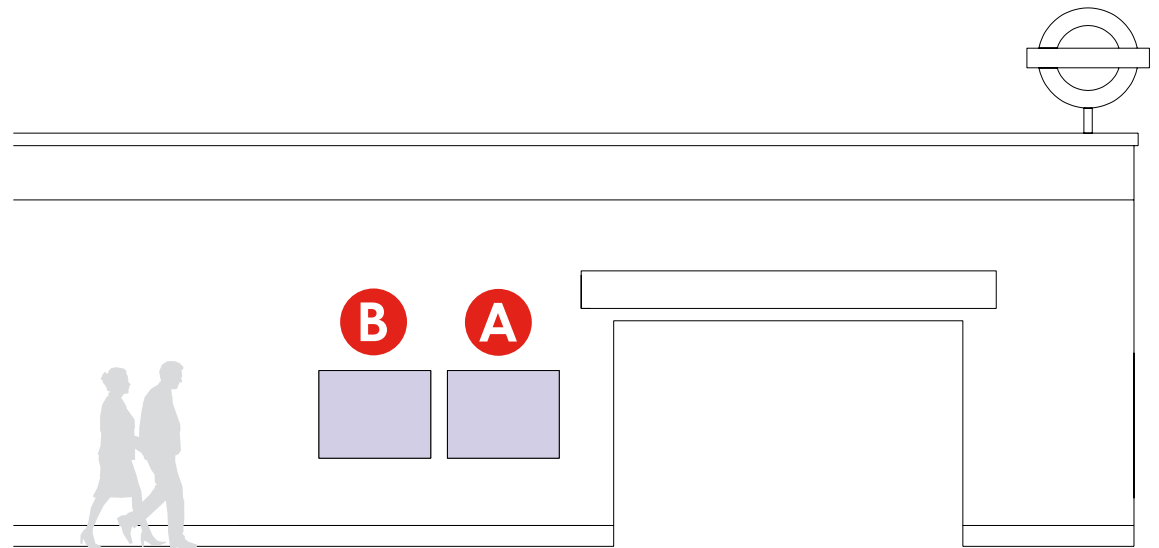

4.2 Station poster requirements - ticket halls (entering)

The minimum requirements for poster frames within a ticket hall when entering are as follows:

- A London connections - Quad Royal
To be visible just before ticket machines
- B Engineering works - Double Royal
To be easily visible before ticket barriers
- C Timetable - Double Royal
To be as close to the London connections as possible (quantity dependant on number of TOCs using station)

- D Customer contacts - Double Royal
Positioned to be visible to customers entering and leaving station
- E Penalty fares - Double Royal
To be visible just before ticket machine
- F Leaflet racks - Double Royal
Next to or opposite ticket windows
- G A-Z posters - Double Royal
To be easily visible before ticket barriers

- H Circuit - Double Royal
- J Ticket office opening hours - Double Royal
To be easily visible near to ticket windows

Ticket hall - customers entering station

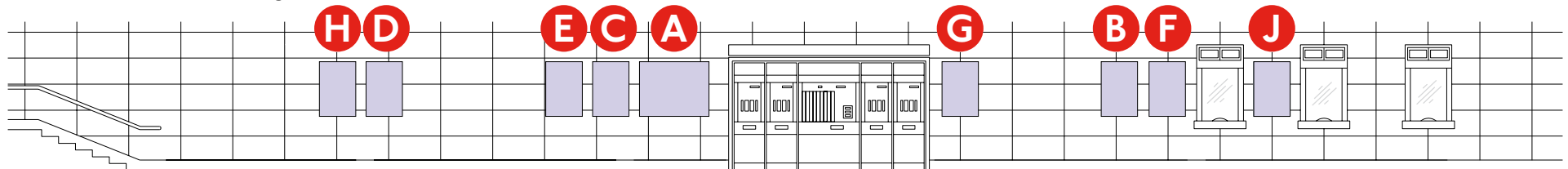

4.2.1 Station poster requirements - ticket halls (exiting)

Contents



The minimum requirements for poster frames within a ticket hall when exiting are as follows:

- A Local information display - Quad Royal
Visible to customers leaving station from barrier line
- B Circuit - Double Royal
- C Customer contacts - Double Royal
Positioned to be visible to customers entering and leaving station

Ticket hall - customers exiting station

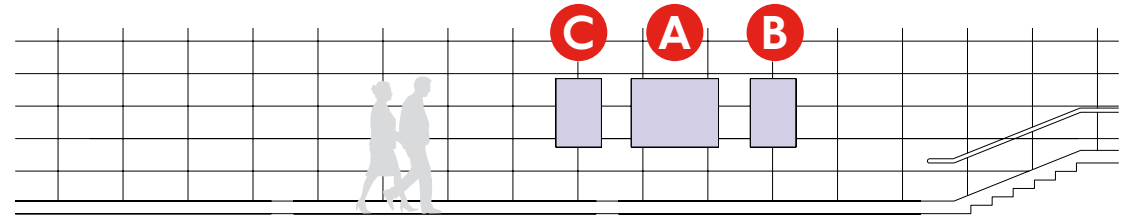

4.3 Station poster requirements - platforms (entry points)



The minimum requirements for poster frames on a platform (at entry points) are as follows:

- A London connections - Quad Royal
To be immediately visible on entry to platform
- B Timetable - Double Royal
To be immediately visible on entry to platform

- C Circuits (various sites) - Double Royal
Positioned throughout the main waiting areas of the platform (may be used flanking London connections map for symmetry)
- D Penalty fares - Double Royal

Platform - entry point

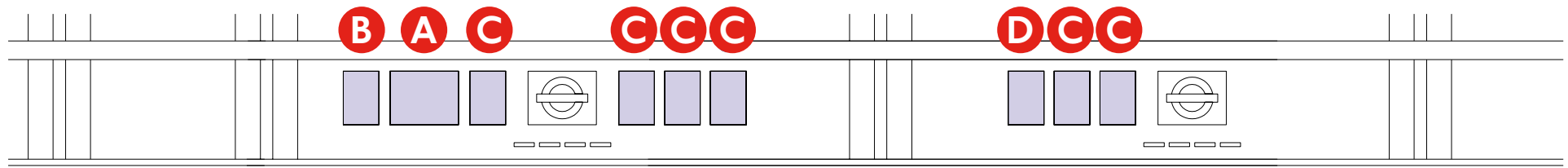

4.3.1 Station poster requirements - platforms (additional entry points)



The minimum requirements for poster frames on a platform (at additional entry points) are as follows:

- A Tube map - Quad Royal
To be immediately visible on entry to platform from additional entry point
- B Timetable - Double Royal
To be immediately visible on entry to platform from additional entry point.
Quantity dependant on number of other operators using station

Platform - additional entry points

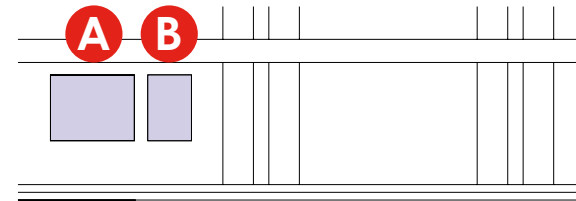

4.3.2 Station poster requirements at key decision points on platforms (and throughout a station)

Contents



The minimum requirements for poster frames on a platform and at key decision points are as follows:

- A London connections - Quad Royal
Required at all key decision points in passageways around the station
- B Circuits (various sites) - Double Royal
Positioned throughout the main waiting areas of the platform (may be used flanking London connections map for symmetry)

Key decision points throughout station

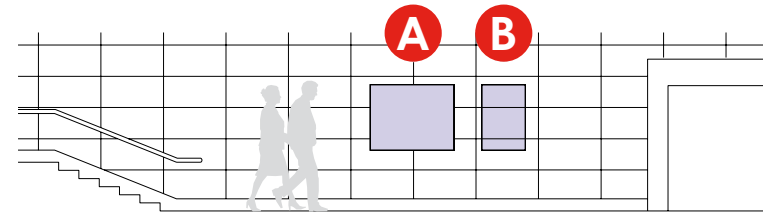

5 Customer information poster site plans

To enable station staff to identify the correct frames when replacing posters, TfL maintain schematic plans of all stations, these plans show the individual frame numbers and poster references for all sites throughout the station. Each frame shall be allocated an individual reference number taken from the station poster site plan.

If poster frames are to be resited during a project, eg due to hoardings, this must be communicated to TfL before the frames are resited. This will ensure that the plans are amended and reissued to staff to enable the correct posters to be displayed. Frames must display a standard black on white vinyl label (NJ Light 34pt) inside the glass as shown.

Stations are periodically scored by auditors against the poster plans, so any discrepancies may be reflected in the performance score.

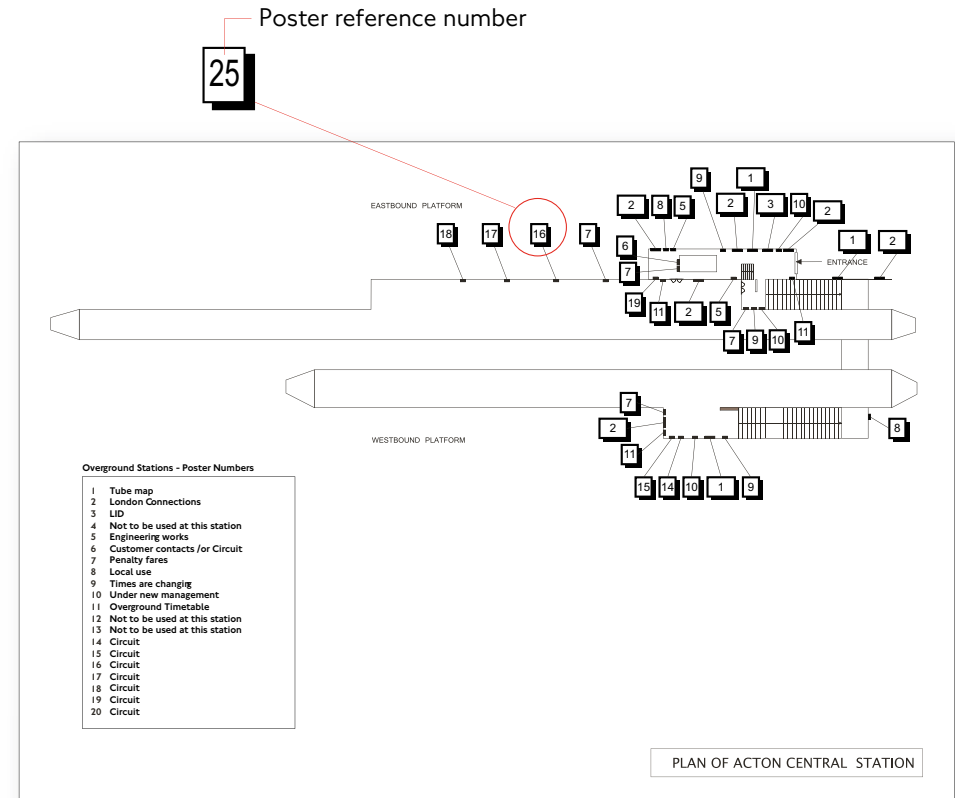

Typical customer information poster site plan

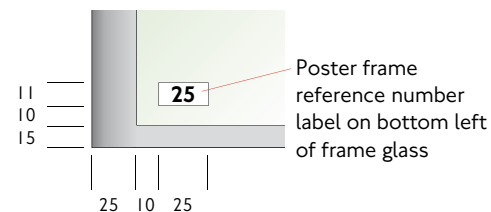

For further information

Contents



These standards intend to outline basic principles and therefore cannot cover every application or eventuality.

In case of difficulty or doubt as to the correctness in the application of these standards, please contact TfL Corporate Design.
Telephone: **020 7126 4462**
Internal extension: **64462**
Email: **corporatedesign@tfl.gov.uk**

All TfL corporate design standards are available from the TfL internet site.
tfl.gov.uk/corporatedesign

Issue 2, January 2009

© Transport for London