



RIVER CROSSINGS: SILVERTOWN TUNNEL

SUPPORTING TECHNICAL DOCUMENTATION

NEW THAMES RIVER CROSSING: INITIAL ENGINEERING FEASIBILITY REVIEW SUMMARY REPORT (SILVERTOWN AREA)

Hyder Consulting

July 2009

This report is a high level assessment of the engineering feasibility of options for river crossings in East London including road tunnels, road bridges and foot bridges.

This report is part of a wider suite of documents which outline our approach to traffic, environmental, optioneering and engineering disciplines, amongst others. We would like to know if you have any comments on our approach to this work. To give us your views, please respond to our consultation at www.tfl.gov.uk/silvertown-tunnel

Please note that consultation on the Silvertown Tunnel is running from October – December 2014



Transport for London
New Thames River Crossings
Initial Engineering Feasibility Review

Summary Report



Transport for London

New Thames River Crossings

Initial Engineering Feasibility Review

Summary Report

Author Various

Checker Phil Tindall

Approver Phil Bailey

Report No 2-LN01198-LNR-03

Date 14 July 2009

This report has been prepared for Transport for London in accordance with the terms and conditions of appointment for Initial Engineering Feasibility Review. Hyder Consulting (UK) Limited (2212959) cannot accept any responsibility for any use of or reliance on the contents of this report by any third party.

Revisions

Revision	Date	Description	Prepared By	Approved By
01	7/4/09	Issued to TfL	Various	P Tindall
02	23/6/09	Additional options considered	Various	P Tindall
03	14/7/09	Minor revisions to suit comments		P Tindall

CONTENTS

1	Introduction	1
2	Background	2
3	Transportation requirements	3
3.1	Strategic Assessment.....	3
3.2	Transport Design Issues.....	6
4	Considerations common to all options	8
4.1	The Safeguarded Route	8
4.2	Geology and Ground conditions	9
4.3	Archaeology.....	12
4.4	Contamination	13
4.5	Environmental.....	13
4.6	Flood Levels	15
4.7	London Underground Constraints.....	15
5	General Design considerations relevant to bridge options	16
5.1	Navigation issues	16
5.2	Aviation issues.....	28
5.3	Protected views	28
5.4	Specific Environmental Aspects	29
6	Highway alignments and associated constraints for bridge options ..	30
6.1	Initial corridor alignments considered	30
6.2	Alternative corridor alignments	31
7	Highway Bridge options.....	34
7.1	Low level opening bridge.....	34
7.2	Mid level opening bridge.....	36
7.3	High level fixed bridge	37
8	General Design considerations relevant to tunnel options.....	39
8.1	General.....	39
8.2	Regulatory Background	39
8.3	Navigation	39
8.4	Specific Environmental Aspects	40
8.5	Gradients.....	40
8.6	Fire and Life Safety	42
8.7	Cross Section	42
9	Highway alignments and associated constraints for tunnel options...	44

9.1	Alignments considered	46
10	Tunnel options	48
10.1	Tunnel Types.....	48
10.2	Geotechnical Conditions.....	49
10.3	Effects on Vertical Alignment.....	49
10.4	Preferred Tunnel Options	51
10.5	Blackwall Tunnel 3 rd Bore	52
10.6	Fire Life Safety in Tunnels.....	53
10.7	Pedestrian Usage	60
10.8	Conclusions	61
11	Footbridge Options.....	63
11.1	Original Footbridge Form.....	63
11.2	Bridge location.....	63
11.3	Bridge Type and Form.....	72
11.4	Pedestrian options.....	72
12	Cost Estimates	74
13	Risks.....	75
14	Discussion and Recommendations for further studies.....	75

Appendices

Appendix 1	Commissioning Brief
Appendix 2	Background Documents
Appendix 3	London City Airport Safeguarded Surfaces
Appendix 4	Protected and Local Views
Appendix 5	Highway Alignments for main options
Appendix 6	Geotechnical Information
Appendix 7	Bridge Drawings
Appendix 8	Tunnel Drawings
Appendix 9	Cost Estimates
Appendix 10	Programme
Appendix 11	Drawings of secondary options

1 Introduction

Hyder consulting was awarded a commission by TfL on 23 February 2009 to carry out an engineering feasibility study for a new Thames crossing in the Silvertown area.

The brief for the study requires a range of concepts to be considered, including highway tunnel options, highway bridge options and footbridge / cycle-bridge options. The original commission brief issued by TfL is reproduced in Appendix 1 with modifications to suit the date of award of the commission and to include the assessment of risk.

An initial draft of the report was issued on 7 April 2009, following which TfL requested additional options to be examined. The additional options include a dual carriageway bridge and dual carriageway tunnels at the original locations, a dual carriageway tunnel near to the Thames barrier and further footbridge options.

This document presents the findings of the original study and the additional options as one integrated document.

The report starts with sections noting issues common to all options, followed by sections relating to the highway bridge options, the tunnel options and the footbridge options. Costs and risks are presented in the next sections. The study has found a number of issues relating to the proposed crossing and these are summarised and discussed in the final section of the report.

2 Background

The provision of additional Thames crossings to the East of London has been the subject of preliminary studies and discussion for many years. Investigations have been carried out for a number of routes including an additional crossing linking North Greenwich and Silvertown. Several variations in alignment have been studied for this particular crossing and one particular alignment has been safeguarded.

Discussion with TfL on 24 February 2009, 5 March 2009 and 22 April 2009 have confirmed that the alignment options for the study should not be confined to those shown on the earlier reports which roughly correspond to the safeguarded route. Whilst these are a good starting point, TfL advised that consideration should also be given to alternative alignments, including options for a tunnel near to the Thames barrier.

Considerable archive material is available from previous studies of crossings in the Silvertown and Blackwall area. Most of the reports were prepared in the 1980's and 1990's and many were reviewed by Hyder in 2002. Whilst dated, they are still a good source of material and the presence of contamination, archaeological remains, geology etc. are likely to be still relevant. Appendix 2 gives a list of those reports that have been retrieved to date and copied onto a Hyder SharePoint site for ease of access by the team.

The current study is primarily a high level engineering feasibility of the options given in the brief. Transportation studies, environmental considerations, architecture, land ownership and planning issues have only been very briefly examined in this study. There have been no consultations with relevant stakeholders, site surveys or attempts to locate services. Further studies will therefore be necessary for a full appraisal of a crossing at this location.

3 Transportation requirements

3.1 Strategic Assessment

In reviewing the alternative crossing options this section provides a strategic assessment of some of the transportation issues that may need to be considered as part of the wider assessment of the crossings. These are limited to a comparison of some of the wider transport issues, not a complete transport assessment of each alternative as this is outside the scope of this study.

When examining the issues associated with the transportation benefits of each of the crossing options, it is useful to examine briefly the long history of previous studies of crossing options. The gradual reduction in port-related activities in East London since the late 1940s and the changing land uses and increase in commercial, residential and light industrial development gave rise to a growing interest in new river crossings to promote connectivity between the south east and north east parts of the capital. Since the mid 1980s, there have been a number of studies, consultations and, in some cases, Public Inquiries that have examined crossings between the Isle of Dogs and Thamesmead, culminating in the most recent Public Inquiry into the Thames Gateway Bridge between Beckton and Thamesmead. Each of these crossing proposals has had to try to articulate answers to a number of key questions relating to transport, including:

- what are the primary objectives of the crossing?
- does it comply with legislation and the latest planning and development guidance (in its various forms)?
- what are the transport benefits?
- who should be and who are the recipients of those transport benefits?
- how do the transport benefits promote economic regeneration?
- what is the real cost to the environment? and
- is this an acceptable cost to pay relative to the other benefits achieved?

This is especially true of the latter crossing proposals, where the role of transport in supporting regeneration and increasing concerns about climate change and the role of road traffic in producing adverse environmental emissions have questioned, among other things, which transport modes should be accommodated on any future crossing. In recent strategy documents, criteria have been set down to try to help judge the worth of any new transport scheme. In particular, both the London Plan and the Mayor's Transport Strategy identify similar criteria for judging new road schemes, namely, that all road schemes in London should:

- contribute to London's economic regeneration and development
- not increase the net traffic capacity of the corridor unless essential to regeneration
- provide a net benefit to London's environment
- improve safety for all users
- improve conditions for pedestrians, cyclists, disabled people, public transport and business; and
- integrate with local and strategic land use planning policies

Where schemes worsen conditions when judged against any of these criteria, the scheme should not proceed unless benefits in other areas very substantially outweigh any disbenefits, and unavoidable disbenefits are mitigated. The Inspector's Report for the Thames Gateway Bridge is useful in determining how the Inquiry viewed the effects of that crossing relative to these criteria. In presenting our strategic overview, we have assessed each crossing with respect to these criteria as an initial guide as to the key areas of difference. The results are shown in Table 1. It can be seen that all of the main vehicular crossing options are similar in terms of satisfying the key criteria set out in the London Plan and the Mayor's Transport Strategy.

The cycle/ pedestrian crossing option has also been compared against the criteria, although this is not strictly a 'road scheme'.

The additional options for dual carriageway crossings considered in the update of the study have not been reviewed in this section of the report.

Table 1 Strategic Assessment of Key Criteria in Relation to Transport

Criteria	Transport Assessment of Options					
	Option 1	Option 2	Option 3	Option 4	Option 5	Option 6
	Third Bore at Blackwall Tunnel	High Level Single C/W North Greenwich to Silvertown	Mid Level Single C/W North Greenwich to Silvertown	Low Level Single C/W North Greenwich to Silvertown	Low Level Cycle/Footbridge North Greenwich to north bank	Road Tunnel North Greenwich to Silvertown
Regeneration and Development	May help support regeneration and development of Greenwich peninsula	May help support regeneration and development of Greenwich peninsula	May help support regeneration and development of Greenwich peninsula	May help support regeneration and development of Greenwich peninsula	No regeneration effect.	May help support regeneration and development of Greenwich peninsula
Traffic Increase	Strategic link between the A12/ A13 and the A2. The additional capacity would generate additional traffic unless controlled by tolls.	Strategic link between the A12/ A13 but provides slightly more diverse routing options north of Thames. The additional capacity would generate additional traffic unless controlled by tolls.	Strategic link between the A12/ A13 but provides slightly more diverse routing options north of Thames. The additional capacity would generate additional traffic unless controlled by tolls.	Strategic link between the A12/ A13 but provides slightly more diverse routing options north of Thames. The additional capacity would generate additional traffic unless controlled by tolls.	No traffic increase, but potential for small/negligible reduction in traffic.	Strategic link between the A12/ A13 but provides slightly more diverse routing options north of Thames. The additional capacity would generate additional traffic unless controlled by tolls.
Environment ⁽¹⁾	May help support regeneration and development of Greenwich peninsula	May help support regeneration and development of Greenwich peninsula	May help support regeneration and development of Greenwich peninsula	May help support regeneration and development of Greenwich peninsula	No significant environmental impact (as far as transport is concerned – see Note 1)	May help support regeneration and development of Greenwich peninsula
Safety	Notwithstanding different safety rates on different classes/ standards of road, significant increases in traffic will increase accidents (as pointed out by Inspector on TGB).	Notwithstanding different safety rates on different classes/ standards of road, significant increases in traffic will increase accidents (as pointed out by Inspector on TGB).	Notwithstanding different safety rates on different classes/ standards of road, significant increases in traffic will increase accidents (as pointed out by Inspector on TGB).	Notwithstanding different safety rates on different classes/ standards of road, significant increases in traffic will increase accidents (as pointed out by Inspector on TGB).	Depending on level of cycle generation, may be slight increase in cycle accidents	Notwithstanding different safety rates on different classes/ standards of road, significant increases in traffic will increase accidents (as pointed out by Inspector on TGB).
Conditions for pedestrians, cyclists, PT, and business	Can improve PT and goods vehicle operation. Special facilities are required to permit pedestrian and cycle movements	Can improve PT and goods vehicle operation but high level will be unattractive for cyclists & pedestrians	Can improve PT and goods vehicle operation, slightly better for pedestrians and cyclists than Option2	Can improve PT and goods vehicle operation but improved conditions for pedestrians and cyclists compared with Options 2 and 3.	Improved conditions for pedestrians and cyclist but no improvement for PT or goods vehicles	Can improve PT and goods vehicle operation. Special facilities are required to permit pedestrian and cycle movements
Integration of land use policies	In London Plan and supported by LBs Newham and Greenwich (subject to detailed planning and it being a tunnel).	In London Plan and supported by LB Newham, Greenwich prefer tunnel	In London Plan and supported by LB Newham, Greenwich prefer tunnel	In London Plan and supported by LB Newham, Greenwich prefer tunnel	Consistent with cycling/ pedestrian land use policies in all relevant plans	In London Plan and supported by LBs Newham and Greenwich (subject to detailed planning and it being a tunnel).

Note (1) For a wider assessment of other environmental issues (such as visual intrusion etc), see Section 4.4

3.2 Transport Design Issues

The highway tunnel and bridge options provide improved strategic road links that increase network functionality and accessibility for road traffic. The dedicated cycle and pedestrian crossing targets the local movements between the Greenwich peninsula and Newham and, in particular, the needs of the O2 Arena. After an event at the arena, the North Greenwich underground station on the Jubilee Line is the only readily accessible rail public transport. A number of bus routes service the Arena but accessibility by public transport from immediately north of the river could be improved. A new cycle/ pedestrian bridge from the peninsula to the north bank could, depending on the landfall, provide a link to the DLR and/ or the underground at Canary Wharf.

Any new road crossing in this location will have to form part of a coherent network with the two existing Blackwall Tunnel tubes. The challenge is to integrate the new crossing with the existing tubes, particularly as the existing northbound tunnel is sub-standard (having been built for horse drawn vehicles in the late 1890s), while the southbound (eastern tube) is more modern but still built to 1960s standards. Transport design issues that are being considered as part of the comparison of the options include:

Tidal operation:

- the new tunnel bore at Blackwall could easily permit tidal operation in the peak periods but this will affect the road connection requirements and local junction arrangements on the A102 north and south of the river;
- the bridge options provide a wider distribution of traffic to the north, but this introduces difficulties in operating the bridge and tunnels together tidally, but, if possible, the option for some form of tidal operation should be maintained;

Public Transport Priority

- Although an initial view on the potential for providing facilities for public transport priority on the approaches to the tunnels/ bridge can be determined, the detailed design of any measures will need to be considered as part of further design studies

Geometric Design

- the ability of the bridges/ tunnels to tie into the existing road networks with acceptable design standards and resulting speed limits and capacities;
- in terms of the bridge options, the gradients of the bridge will affect the attractiveness and ease of use for pedestrians and cyclists
- in terms of the tunnel options, the question is whether pedestrians can be accommodated in the new tunnels (using the emergency walkways for example) and what are the safety and operational risks in doing this.

At this stage, where relevant, these issues have been considered as part of the design studies. Other issues associated with these design issues would need to be examined in more detail at a subsequent stage, once the initial option assessment has been completed.

In addition to the general design issues outlined above, there are two additional factors that will affect the crossings and need to be considered in more detail in this section as they relate to more fundamental policy decisions relating to crossing operations:

- Tolling: If the bridge and existing tunnels are to be tolled then how will the tolls be collected and what form will the tolls take (for example one-way or two way tolls);
- Operation of a two lane tunnel two-way: This has safety and capacity issues that can affect the design (and hence cost) significantly.

Tolling of the Crossings

Our understanding is that the new road crossing and the existing Blackwell Tunnels would be tolled. Traditionally, this would give rise to the need for a toll plaza to collect tolls either in one direction or in both directions. In designing a toll plaza, there are a number of factors that need to be considered, primarily:

- the types of toll collection allowed (manual, coin box, credit card, electronic tag, ANPR with pre or post payment etc)
- the storage space to accommodate queues at the toll plaza (the balance between the land required for toll booths and the ability/ willingness to queue traffic on the approaches);

Many modern tolls are collected automatically through tag-based free-flow systems, eliminating the need for toll plazas. The current ANPR congestion charging system in London is likely to move to some form of TAG system in the future. For the purposes of this report, we have assumed that the tolling system will be free-flow (either using ANPR or some form of tag-based system) that would logically be linked to the congestion charging system in other parts of London. Therefore, no toll plazas have been assumed in the designs.

Operation of a Two Lane Tunnel Two Way

There are a number of safety issues that must be considered in operating a two lane tunnel two-way. There is an increased risk of an accident if a vehicle breaks down and other vehicles cannot pass without moving into the lane used by oncoming vehicles. Also, in the event of a fire, two way operation causes additional problems with tunnel ventilation and evacuation. These and other safety issues have been considered as part of the tunnel designs. The need for separate pedestrian escape tunnels, hard shoulders, and walkways are all discussed. In addition, the requirements to allow pedestrians to use the tunnels to cross the Thames are also considered.

4 Considerations common to all options

4.1 The Safeguarded Route

In 1997, the Government Office for London issued a safeguarding direction for the Blackwall-Silvertown Crossing. The safeguarding direction was transferred to the Mayor for London on 21 May 2001. Whilst both London Borough of Newham and London Borough of Greenwich safeguarded the route in their Unitary Development Plans (UDPs), the alignment differs between the plans. Specifically, the LB Greenwich UDP shows the route to be slightly further south than the adopted LB Newham UDP, which shows the same alignment as the 1998 Mott McDonald Report.

Creating an alignment that is wholly within both Borough Plans is not feasible, although it is possible to create an alignment with the carriageway centreline running along the boundary of each. In discussion TfL have advised that consideration should be given to appropriate alternative alignments.

On the Newham side the safeguarded route extends north from Bell lane into an area currently occupied by Carlsberg industrial units. The remainder of the land in the safeguarded zone on this side of the river, although in use, appears more temporary in nature, such as car parks and concrete batching plants. To the south of Bell lane is an extensive Akzo Nobel facility.

On the Greenwich side the safeguarded zone covers the Blackwall Tunnel Approach Road and Millennium Way and two areas of land to the east of these roads. The freehold / leasehold status of these areas of land has not been established but there is currently a developer's signboard on the vacant plot at the corner of John Harrison Way and East Parkside and work appears to have started on site to develop both plots into significant residential developments.

The area considered for the Blackwall to Silvertown link in this study is otherwise defined by the need to connect the North Greenwich Peninsula to existing east-west links to the north and east of the Thames. This creates an Area bounded on the **South Bank of the river by:**

To the north: North Greenwich Station (JLE) and the JLE itself running ENE under the River to Canning Town Station;

To the south: the limit of land availability within the Peninsula development, probably defined by John Harrison Way;

To the west by the A102 (M) and the parallel Millennium Way which together form a barrier between the old and new sections of the Peninsula;

On the **North bank of the river** the area is bounded to the north and east by the new DLR extension to London City Airport, backed by new residential development and the Royal Victoria Dock. The new DLR Extension to London City Airport is on viaduct and forms an effective barrier to the north and east. However some provision has been made for the Protected Corridor by providing two longer spans and an adjustment to the alignment to create a less acute crossing of the Corridor. This provision appears to have been made with a view to connecting the highway to the existing at-grade roundabout on the A1020 Silvertown Link. At the south end of the Study Area, there is a large vacant plot currently used as event car parking for Excel. To the north east of this are two industrial plots currently containing a paint factory and a beverage

distribution depot respectively, then a further plot with apparently temporary land use. All of these plots have river frontage.

The study also considers an alternative location near to the Thames Barrier bounded by the A206 on the South side of the River and the A1020 on the North side of the river and extending up to 800 metres East and West of the barrier.

4.2 Geology and Ground conditions

A number of studies have been undertaken for a crossing at Silvertown and information has been extracted from these studies. The previous ground condition information does not cover the exact locations for the bridge or tunnel crossings. The information available is, however, considered to be adequate for a preliminary assessment of the crossings.

It is considered unlikely that the geotechnical conditions will fundamentally impact on the choice of the road bridge options but they could have a significant influence on the choice of tunnel option and possibly the footbridge options. If the tunnel option is likely to be carried forward, a preliminary site investigation at the proposed location would be recommended.

4.2.1 Ground Conditions

A reasonable amount of information is available on the ground conditions at Silvertown particularly along the line of the Blackwall Tunnel. The proposed road bridge and tunnel crossings lie downstream of the tunnels and close to the line of the new Jubilee Line Tunnels. One of the proposed footbridge locations lies close to the bridge locations while the other lies upstream from the Blackwall Tunnel.

Information from the 1990 Jubilee Line Extension site investigation is still being sourced, but geological longitudinal sections for the previously proposed bored tunnel and immersed tube tunnel options are available as presented in the 1993 report by Travers Morgan. A geological longitudinal section showing anticipated conditions in the area of the road bridge crossings based on that report is shown in Appendix 6. Infilled scour hollows are shown to be present in the Blackwall Tunnel area but these are not indicated on the attached section. Further site investigation data would be required to confirm this assumption.

The general succession in the area comprises Made Ground, Alluvium, Peat, Terrace Deposits, London Clay, Blackheath Beds, Woolwich and Reading Beds, Thanet Beds, Bullhead Beds and Upper Chalk.

Made Ground – extensive areas of made ground cover the areas north and south of the Thames. Much of the made ground is contaminated through the industrial activities in the past, particularly on the south bank.

Alluvium and Peat – the alluvium generally comprises soft to firm grey and brown silty clay containing pockets of fine sand and gravel, shells and plant remains. Several impersistent layers of peat up to 2.2m thick occur within the clay. A distinct basal layer of fine to medium light brown sand with pockets of clay is present in many places.

Terrace Deposits – these deposits which are generally 4 to 8m thick generally comprise medium dense to very dense fine to coarse well graded sub angular to rounded flint gravel with much fine to coarse slightly silty sand. The terrace gravels are in hydraulic continuity with the Thames although isolated perched water tables can occur.

London Clay – comprises a stiff to very stiff brown and grey brown closely fissured very silty clay with frequent lenses and partings of fine grey and black (pyritic) silty sand. The thickness varies between 2 and 20m with generally the thinnest being encountered towards the south where the sequence feathers out.

Blackheath Beds – occasionally cemented grey fine to medium sand, silt or clay with frequent flint pebbles and pebble beds. The Beds occur intermittently throughout the area and are absent in many areas and generally less than 0.5m in thickness.

Woolwich and Reading Beds (now included within the Lambeth Group) – The Woolwich and Reading Beds are a complex series of cohesive and cohesionless strata. In this area three stratigraphic units are encountered – non cohesive material (Laminated sands and silts) over cohesive material (Lower Shelly clay & Lower Mottled Clay) which in turn overlies non cohesive material (Pebble Beds & Glauconitic Sand) The laminated sands and silts comprise a series of light brown and grey brown thinly laminated silty fine sands and fine sandy silts containing extremely closely to closely spaced bands of stiff dark brown and grey brown fissured laminated clay. The Lower Shelly clay is a stiff or very stiff closely fissured laminated over consolidated grey brown clay containing occasional zones of abundant shells. The Lower Mottled clay is more variable and comprises a stiff grey brown mottled brown to off white slightly sandy clay with pockets of calcareous matter. Frequent closely spaced lenses of firm dark green silt up to 60mm across were also encountered. There is also an intermittent occurrence of a band of weak to moderately strong Limestone. The Pebble Beds occur as a grey green occasionally mottled brown slightly clayey silty fine to medium sand with fine to medium rounded to sub rounded flint gravel and very closely spaced laminae of soft to firm green clay. The Glauconitic Sand is similar to the Pebble Beds comprising a grey green slightly silty fine to medium sand with very closely spaced laminae and lenses of stiff green clay and occasional flint gravel.

Thanet Beds – comprise a dense to very dense grey green silty fine glauconitic sand with medium to closely spaced green laminations – becoming siltier with depth with frequent pockets of silty clay towards the base. Despite the high density the Thanet Beds are prone to collapse in open excavations under high hydrostatic pressures. The thickness varies between 13m and 17m

Bullhead Beds – these beds form the basal layer of the Thanet Beds and comprise a thin band of dark green rounded pebbles in a glauconitic silty clay matrix. Thickness is less than 0.2m.

Upper chalk – Chalk underlies the whole of the area with an estimated thickness of 200m. The Upper Chalk is a porous off white limestone containing gravel bands and flints. In the upper 1 to 2m the material has been weathered to a weak to moderately weak material; below this the chalk is generally moderately strong.

Scour and uplift features have been proved in the Blackwall Tunnel area. It is indicated that these features extend to the west and east of the Blackwall Tunnel but the detail is uncertain as there is not sufficient ground information. Further site investigation would be required to identify the extent of these features

4.2.2 Engineering Consideration

Based on the limited amount of information available, a general summary of the engineering considerations is given in the following discussion.

Scour

As noted above, it is not considered that the geological conditions will be a major driver in the choice of the road bridge options or location. It would however be recommended to avoid the location of any scour features as proved in the area of Blackwall Tunnel. The overall extent of the scour features is not sufficiently well known to allow definitive comments to be made at this stage. It is however considered that there is a higher probability of the footbridge upstream from the Blackwall Tunnel encountering scour features than the footbridge or road bridges downstream of the tunnel. Further ground information is required to confirm this statement.

Uncharted boreholes

It is possible that there are a number of uncharted boreholes in the area that may not have been backfilled effectively. These may have an impact on the bored tunnelling options, although this is likely to be carried out with an earth pressure balance machine that can be sealed. The boreholes could also impact on shaft construction – significant delays were encountered on the Brighton tunnel due to water inflow through boreholes in a shaft.

Hard bands within the Lambeth Group and London Clay

There is a potential for obstructions to be encountered in some of the materials likely to be encountered. There are hard beds in the Lambeth Group up to 1.5m thick with UCS values of up to 50MPa. Hard bands have also been proved in the London Clay and Harwich formation up to 0.3m with a UCS of up to 100MPa. These are likely to have a greater impact on the bored tunnel option than any other but they could result in delay to piling works.

Absorption of Oxygen

There have been cases of absorption of oxygen in works within the Lambeth Group and Thanet Sand Formation. This could impact the tunnel options and also the foundation options where caissons are adopted. An excavation into the Woolwich and Reading beds (Lambeth Group) could be required for the road and foot bridge pier foundation construction.

Unexploded ordnance

Unexploded ordnance has been located in a number of areas within the Thames corridor. Ordnance would penetrate the alluvial and peat material but would not penetrate a great distance through the Terrace Gravel deposits. This could impact the tunnel options particularly as the tunnel in the Silvertown area would appear to be relatively shallow. This would also impact any piling scheme in the area.

Foundations

The road and foot bridge options will require either piled foundations or caisson construction for the support towers. It will be necessary to excavate to about -8.5m OD for the support towers for the road and pedestrian bridges. Piers constructed within caissons and founded at about -20m OD within the Woolwich and Reading Beds (Lambeth Beds) are recommended rather than piled foundations. It may be required to address problems of lack of oxygen in excavations particularly within the Lambeth Group. For the approach spans for the bridge crossings it is anticipated that bored cast in situ piles would form an appropriate foundation, with the piles being founded in the lower Woolwich and Reading material. If it was proved that the piles had to be extended to be founded within the Thanet Sand it is considered that the piles would require base grouting.

The most cost effective foundations for the approach spans for the footbridges will probably be driven cast in situ piles founded within the Terrace Deposits. Pre-cast piles will probably not be acceptable to the Environment Agency as they may be perceived as forming a pathway for contamination to the Terrace Deposits or possibly 'drag' contamination into the underlying alluvium and Terrace Deposits.

Tunnels

A bored tunnel at Silvertown would be relatively shallow with the crown of the tunnel possibly within the Terrace Deposits for a section of the tunnel. The materials at the face are likely to be mixed, with London Clay and Woolwich and Reading material (Lambeth Group) generally being encountered. Hard bands have been proved in the London Clay and Lambeth Group which have caused damage to the cutting edge in previous tunnelling projects in the area. The fact that the Jubilee Tunnels are in place indicates that the proposed works are feasible.

Immersed tube construction will require dredging and it is likely that for Silvertown the invert will be in the lower Woolwich and Reading Beds (Pebble Beds and Glauconitic Sand)

4.3 Archaeology

The North and South banks of the Thames, at the proposed crossing locations, have been the locations for a variety of industrial and shipping usage over several centuries. As such, there is archaeological interest in the area due to the historic use.

Two archaeology reports are on record. The 'Blackwall Tunnel Third Bore Archaeological Assessment' (Oxford Archaeological Unit, 1991) divides findings into those in the study area on the north and south banks of the Thames. Firstly, on the north bank there is the potential for palaeoenvironmental remains of the early history of the river in the alluvial clay and peat layer referred to in the report. Prehistoric, Roman or Medieval findings are possible and remnants of Armada "boom and fortlets" are possible but no locations specified. The Blackwall shipyard area is identified as having potential for extensive remains. Remains of the railway dock are considered of minor interest.

The 'A102 Blackwall Third Crossing River Bridge, Report on Archaeology' (Travers Morgan Ltd, 1993) reports on archaeological observations and excavations. Excavations have confirmed that substantial remains of the 17th century dock of

Blackwall Yard identified in the 1991 report might exist, including timber structures. Surviving river frontages offer the opportunity to trace early development of the area from late medieval period onwards. A 19th century Colliers dock is of interest for industrial archaeology of coal trade in London north of the Thames. The Charrington's Wharf site is identified as requiring further archaeological investigation before any construction work.

The land on the South Bank has subsequently been subject to extensive remediation for development of the dome (O₂ arena) and surrounding infrastructure.

While the alignments of the current bridge and tunnel options differ from those assessed in 1991 and 1993, it is assumed that the study area has the potential to exhibit similar important archaeological features and artefacts. All options would require further archaeological investigations given the likely extent and depth of excavations.

Once an alignment for the crossing is determined, it will be necessary to carry out a comprehensive archaeological desk study to determine whether any excavations or mitigation measures are necessary.

4.4 Contamination

Contamination has been located in the area particularly on the south side of the Silvertown crossing. This is unlikely to impact on the design but could be a significant aspect of the construction works and environmental constraints.

The 'A102 Blackwall Third Crossing Report on Contamination' (Travers Morgan Ltd, 1993) reports that land contamination is a major issue within the study area due to its previous industrial uses. Historically, the north bank was marshland, docks, a railway terminal and an oil terminal. Previously located on the south bank were a marshland, gasworks and tarworks.

In 1993, a site investigation was undertaken which revealed moderate contamination on the north bank due to organic species. The south bank was heavily contaminated due to coal tars, which had also migrated into the underlying natural strata. Landfill gas and contamination of groundwater was also detected in the 1993 site investigation.

While the alignments of the current bridge and tunnel options differ from those assessed in 1993, and ground remediation has taken place on parts of the Greenwich peninsula, it is assumed that contamination should remain a concern of any option that is taken forward. Further investigations into land contamination would be required for all options. Excavation should be kept to a minimum as all excavation material would need to be tested and disposed, if necessary, in an appropriate manner. Mitigation measures would also be required to prevent contaminated run-off entering the Thames or groundwater.

4.5 Environmental

4.5.1 Air Quality

Two of the three boroughs within the study area, Greenwich and Tower Hamlets, have declared the whole borough as an Air Quality Management Area (AQMA) for nitrogen dioxide (NO₂) and particulate matter <10µm (PM₁₀). Newham has declared an AQMA

for these pollutants but only along the main roads within the borough (UK Air Quality Archive, 2009). A number of continuous automatic monitors are operated in the area and 2008 results show that the area is exceeding UK Air Quality Strategy targets for both NO₂ and PM₁₀ (London Air Quality Network, 2009).

The highway bridge and tunnel options aim to relieve congestion. Therefore, in general, air quality in the study area should improve should these options be taken forward. In addition, improvement to vehicle technologies over the next 10 years would contribute to further improvement. There would, however, be localised changes in pollutants from vehicle emissions in that the New Thames Crossing would introduce new sources of pollutants where there previously were none.

4.5.2 Biodiversity and Green Infrastructure

The Thames is the main ecological feature of the study area. It is designated as a Site of Nature Conservation Importance due to its valuable habitat supporting many plant and animal species, including wildfowl and wading birds. The river walls provide a feeding habitat for the nationally rare black redstart. All options for the New Thames Crossing would require further ecological investigations depending on the extent of disturbance of the river and its banks.

An area of Community Open Space is located on the south bank and is crossed by all highway bridge options. There is potential for Greenwich to require compensatory land or enhancement of this area, should the highway bridge options be preferred.

4.5.3 Built Heritage

There are unlikely to be any effects on built heritage for any of the options for the New Thames Crossing. A significant local protected built heritage feature, the Maritime Greenwich World Heritage Site, is over one kilometre from the study area.

4.5.4 Noise

The best available baseline data for noise is Defra's online noise mapping project which shows modelled noise levels for the UK. Viewed at a strategic level, the maps depict that the main sources of noise within the study area are road traffic from the A102 / A12 Blackwall Tunnel Approaches, the A13 and the Lower Lea Crossing. London City Airport also contributes to the ambient noise environment of the study area.

For all bridge options noise sources would be displaced to an area where there has been little noise pollution previously. For the tunnel options noise would be concentrated at the tunnel approaches and there would be no discernable change in noise for the footbridge options.

4.5.5 Water Environment

The Thames is the main water feature within the study area. The River Lea empties into the Thames on the north bank. Both the north and south banks are at risk of flooding. However the area benefits from the protection flood defences (Environment Agency, 2009).

The Environment Agency has undertaken a water quality monitoring programme at the confluence of the River Thames and Lea. The latest results from 2008 shows that the chemistry of the water fails significantly when tested against guideline values, meaning that at this point the water is highly polluted and ecosystems are extremely restricted.

Potential adverse water quality impacts would be required to be controlled through provision of sustainable Drainage Systems in the permanent works, where feasible, and use of pollution prevention techniques during construction.

4.6 Flood Levels

The Thames Barrier, located a short distance downstream of the study area, is designed to protect against flooding from extreme tidal events and rises to a height of 6.9m AOD. Flood defences downstream of the barrier are at a higher level than this (generally 7.2m AOD).

Flood defence levels are maintained upstream of the Thames Barrier at levels varying from 3m AOD to 5m AOD to protect adjacent low-lying land from events when the barrier is not raised and from maximum water levels behind a closed barrier. We understand that the Environment agency is currently reviewing levels of protection to be provided for future works.

For all options, further investigation into the flood risk implications would be required to ensure safe and secure infrastructure.

4.7 London Underground Constraints

All the proposed alignments of the new road crossing will cross over the Jubilee Line Extension tunnels, except for the alignments near to the Thames barrier. London Underground (LUL) has strict requirements regarding any developments that will or have the potential to impact on the integrity of their assets. In particular they do not allow driven piles within 15.0m from any structure or tunnel or bored piles in a zone 6m vertically and 3m horizontally from any structure or tunnel.

If there is any chance of LUL assets being affected by a proposed development then LUL will need to be consulted. This is likely to lead to a formal assurance process where LUL's asset engineers will need to be convinced that there is no risk to their asset.

The depth of the Jubilee line tunnels are such that any bridge piers, abutments or approach structures crossing the line of the Jubilee Line are likely to be subject to some level of assurance process from London Underground.

5 General Design considerations relevant to bridge options

5.1 Navigation issues

The Port of London Authority (PLA) is responsible for “the public right of way of navigation and for conservancy of the River in the Port of London”. It has both legal and lobbying influence to dictate clearance requirements of any potential crossing.

Key issues the PLA will take into consideration will be:

- Safe navigation of the Thames
- Environmental sustainability
- Licensing approval for development work within or over the Thames
- Effects on commercial potential of the port
- Effect of revenues from commercial and leisure users on the Thames.

Any proposal that infringes on the above issues will most probably be objected to by the PLA. In order to illustrate that any proposal has no negative effects of the PLA directives they require an appropriate risk assessment to be undertaken.

For crossings on this section of the Thames, the PLA have previously indicated that a suitable air draft clearance is 54.1m above Mean High Water Springs (MHWS), the same as the next downstream bridge, the QEII Bridge at Dartford. They have also indicated that a navigation width of 200m is probably appropriate.

Existing River Operating Regime at Bugsby's Reach

The Thames River is approximately 450 metres wide at the proposed crossing location. At this point the navigable channel is shown on charts as approximately 180m wide and there is two-way navigation for most vessels. Vessels will navigate outside this channel depending on available depth of water.

The depth of the river in Bugsby's Reach varies between 4.5 to 7.0m below Chart Datum and the tidal range varies between 0.69 to 7.2m above Chart Datum.

Tidal levels are as follows:

Tidal State	Level m CD	Level m OD
Mean High Water Springs (MHWS)	7.2	3.85
Mean High Water Neaps (MHWN)	6.0	2.65
Mean Low Water Neaps (MLWN)	1.49	-1.86
Mean Low Water Springs (MLWS)	0.69	-2.66

The ebb tide in the river runs at about 3 knots and the flood tide at between 2-2½ knots. Vessel speeds in the river will vary depending on the river conditions (ebb or flood) and the need to maintain steerage. For the purpose of this assessment it has been assumed that the speed of the larger vessels over the ground is about 7 knots.

Larger vessels will travel up the river with the flood tide. The allowable under keel clearance is approx 0.8m on a rising tide and 1.2m on a falling tide. Vessels normally travel on the starboard side of the river although larger vessels are likely to follow the deeper water on the outside of bends

The proposed crossing location lies within the upstream boundary of the Thames Barrier Control Zone. At this boundary vessels approaching the barrier from upstream are required to make radio contact with the PLA's Woolwich VTS Centre to obtain clearance to proceed through the barrier and to be advised which spans of the barrier are available for navigation

Shipping Trends

The PLA collects data on vessel movements upstream and downstream through the Thames Barrier. From this data it can be seen that the total number of vessels each year passing through the barrier between 1988 and 2008 is relatively stable and varies between 30,000 and 48,000 refer to Table 2.1. However, the number of larger commercial vessels has decreased from about 6000 to 3000 p.a.

	+107m	-107m	River			Service	Tanks	TOTAL
1988	205	5945	6898			21568	3098	37714
1989	223	5452	6595			22127	2485	36882
1990	258	5848	6665			21977	1707	36455
1991	321	4262	6780			20873	1074	33310
1992	259	3324	4907			20901	1155	30546
1993	286	3369	3622			22062	1057	30395
1994	297	4062	4747			21306	1106	31518
1995	310	4159	6413			24467	924	36373
1996	457	4030	4610			22480	906	32483
1997	492	4437	5148			24785	839	35701
1998	471	4151	3738			23743	799	32902
1999	389	3596	3816			23384	752	31937
	+100m	-100m	Class V	Tows/Barges	Private	Service	Tanks	TOTAL
2000	135	3642	7867	4841	9402	7977	653	34517
2001	77	3989	6866	4882	8798	5149	558	30319
2002	123	4654	6991	5101	10853	6239	608	34569
2003	83	4421	6475	4838	10173	6134	568	32692
2004	88	4156	6723	5327	10721	5732	366	33113
2005	151	3585	8960	5199	10517	5407	293	34112
2006	-	-	-	-	-	-	-	-
2007	122	2087	11839	6362	9005	4979	222	34616
2008	128	2342	23243	7787	8852	5675	211	48238

Table 5.1 PLA Vessel Log 1

The information for the year 2006 was incomplete. There was a considerable increase in the total number of recorded Class V vessels between 2007 and 2008. PLA have confirmed that the criterion for Class V was amended for the year 2008 and as a result included a larger variety of vessels. A brief description of the vessel log categories:-

- +100m Vessels over 100 metres in length
- -100m Vessels under 100 metres in length that do not fall into another category
- Class V All passenger carrier/Thames Cruise/Thames Clipper vessels (before 2008 passenger vessels over certain size)
- Tows/barges Vessels being towed, e.g. barges
- Private Privately owned vessels, e.g. yachts, motor yachts
- Service PLA service vessels e.g. pilots, buoy laying vessels
- Tanks Tankers, e.g. vessels transporting liquids or gasses

Upstream of Thames Barrier the PLA handbook 2008 lists 6 terminals, most of which generally receive relatively small vessels except the Victoria Deep Water Quay, where aggregates etc are handled. In addition, Convoys Jetty which used to handle significant vessels, is currently not in use although operations may restart

Upstream terminals are:

Pier Wharf	Aggregate
CEMEX Fulham Wharf	Aggregate
Cringle Wharf	Aggregate
Brewery Wharf	Aggregate
Victoria Deep Water Terminal	Aggregate
Thames Wharf	Scrap Metal

The list does not include Convoys Jetty in Deptford, which is currently not in use but which may be used in future.

There are two wharves downstream close to the proposed bridge location, Angerstein and Murphy's wharves. These two wharves handle aggregates and the vessel manoeuvring requirements will need to be taken into account in the design of any new bridge.

In addition there are non-industrial organizations that benefit from craft passing up the Thames – Navy, Cruise Ships and passenger craft etc. Cruise and naval vessels visit the Tower of London and Greenwich. In 2009 twenty three visits by cruise vessels are scheduled for either Greenwich or the Tower of London according to the schedule on PLA's website.

Previous studies indicate that there are more vessel movements in the summer months than in the winter.

Typical ships using the river include:

Ship Type	Deadweight Tonnage (dwt)	Length O/all (m)	Beam (m)	Air Draught (m)	Draught (m)	Vessels to pass proposed bridge
Bulk cargo	37,500	185	28	38.7	10.2	No
Small bulk cargo	7,500	124	18	32	7.2	Yes
Cruise Ships						
- The World	N/a	196	29	40	6.7	Yes
- Allow for		240	32.5	45	6.7	Yes
Warships						
- Invincible class	N/a	210	35	45.4	8.9	Yes

5.1.1 Navigation width

PLA have previously stated that they require two-way navigation in the river to be maintained beneath the bridge and that a comprehensive risk assessment should be undertaken prior to the finalisation of any scheme design. The risk assessment would consider all aspects of any crossing that may affect or have a negative impact on navigational safety. PLA will most likely object strongly to any scheme that puts extra constraints on the navigation of the river in Bugsby's Reach.

The largest cruise vessel scheduled to visit Tower Bridge and Greenwich Ship moorings in 2009, is the Prinsendam which has a length of 205m, beam of 28m, air draft of 39m and draught of 7.2m. Using PIANC Approach Channels a Guide for Design we have the estimated width for single-way navigation to be 183 metres. The marked channel width on the PLA Chart 322 is about 180m which is also consistent with single-way navigation for the larger bulk-carriers. For the smaller bulk vessels with DWT of approximately 7500t the two-navigation required is estimated to be about 126m.

5.1.2 Vessel heights and resulting bridge clearance requirements

We have investigated the constraints and operating regime that would result from fixed bridges with vertical clearances of 15, 25, 37 and 50 metres.

Accurate data on vessel air heights is difficult to obtain particularly for smaller vessels. In order to assess the number of openings required for each bridge height considered the following references / sources have been used:

- AASHTO: Guide Specification and Commentary for Vessel Collision Design of Highway Bridges, Figure 3.5.2-5
- PLA visual log of vessels passing through the Thames Barrier (1998-2008)
- PLA's River Information System (POLARIS) records 2000-2008. POLARIS records all vessels passing through the Thames Barrier and is used by the PLA to charge commercial vessels. For this reason, it is considered to be a more accurate record than the vessel log. However, it only records chargeable vessels which make up approximately 10% of total vessels. (PLA advice).
- Lloyds Register
- Previous Reports for Blackwall Crossing (1997) – CWA Engineering
- Previous report for Physical Restraints Review (2005) – Buro Happold Engineers

The current results of the assessment are summarised below:

Bridge Height 15m (Opening)

The bridge would need to open for a large number of vessels including sailing yachts, tugs, hopper barges, aggregate dredgers and larger bulk vessels. It is calculated that there would be more than 15 vessels a day that would require the bridge to be opened.

Bridge Height: 25m (Opening)

The bridge will need to be opened for all significant bulk and general cargo vessels, all cruise and naval vessels, square rig sailing vessels, dredgers, crane barges and HMS Belfast (refit). The data used indicates that there would be approximately 4-5 openings per day.

The study by Buro Happold estimated the number of bridge openings for vessels greater than 21m air draft to be 12 per day. This would appear to conflict with other data, but it is difficult to see where the discrepancy lies from the information that we currently hold. A more detailed study into vessel movements upstream of the proposed bridge using the latest data is required to better estimate the number of bridge openings.

Bridge Height: 37m (Opening)

The bridge will need to be opened for some bulk cargo vessels, most cruise and naval vessels, some crane barges, square rig sailing vessels and HMS Belfast (refit).

A few of the marine aggregate dredgers and smaller bulk cargo vessels that call regularly upstream of the proposed bridge have air draughts of about 35m. The data used indicates that there would be generally only be 1 or 2 openings per day and none at all on some days.

Bridge Height: 50m (fixed)

Nearly all vessels would be able to pass the bridge. A few new and future, large cruise vessels may be restricted. {The next downstream bridge, the QEII Bridge at Dartford has an air draft clearance of 54.1m above Mean High Water Springs (MHWS).}

The effects of sea level rise will also need to be considered in the final selection of bridge height. The EA website suggests an average increase in sea levels for the Thames estuary of 6mm per year i.e. 0.72m over the normal 120 year design life of a bridge.

5.1.3 Criteria relating to opening bridge timing etc.

For the low level bridge options, opening times have been assessed on the same basis as used for previous Lifting Bridge Options studies.

The key parameters in the assessment are:

- Design vessel speed over ground: 7 knots (average)
- Bridge opening time: 4 minutes
- Bridge closing time: 4 minutes

In previous studies for Thames Crossing two bridge opening policies have been considered for outbound vessels: 'Bridge open on departure from berth' or 'Abort procedure'.

For preliminary assessment of likely bridge opening times, abort locations have been selected as follows:

- Outbound – Greenwich Wharf
- Inbound – King George V Lock Entrance

In Tables 5.2 to 5.3 we have estimated the outbound and inbound passage times from the proposed crossing.

Location	5 knots	6 knots	7 knots	8 knots	9 knots
HMS Belfast	76	63	54	47	42
Convoys Wharf	37	31	26	23	20
Greenwich Pier	29	24	21	18	16
Greenwich Wharf	24	20	17	15	13
Victoria Deep Water Terminal	17	14	12	11	10
Proposed Bridge	0	0	0	0	0

Table 5.2 Outbound Times (minutes)

Location	5 knots	6 knots	7 knots	8 knots	9 knots
Flidder's Reach	149	124	106	93	83
Queen Elizabeth 2 Bridge	128	107	91	80	71
Crayford Ness Limit	102	85	73	64	57
Pioneer Wharf	85	71	61	53	47
Ford Motor Jetty	68	57	49	42	38
Barking Creek Limit	43	36	31	27	24
King George V Lock Entrance	30	25	21	19	17
Thames Refinery (Tate & Lyle)	15	13	11	10	8
Thames Barrier	10	8	7	6	6
Proposed Bridge	0	0	0	0	0

Table 5.3 Inbound Times (minutes)

Tables 5.4 and 5.5 give estimated opening times for outbound and inbound vessels respectively. On the assumption that suitable facilities are made available for an abort procedure, then the shortest time applicable to the vessel origin or abort location will govern and the total bridge closure to road traffic time will be approximately 30 minutes for outbound and inbound vessels.

Layby berths will need to be constructed for the ships to tie up in the event that an abort procedure is initiated. It is essential that the abort strategies are safe and there should be confirmed by a detailed programme of ship simulation exercises.

Opening times will be governed by the large vessels which will generally transit the river at high tides.

Location	Bridge Lift Time (min)	Bridge Open Time (min) (7 knots ground speed)		Bridge Lowering Time (min)	Total Bridge Closure to Road Traffic Time (min)	
		Full Pilotage time – bridge open on departure	Adoption of abort approach - Layby at Greenwich Wharf		No abort	With abort
HMS Belfast	4	54	17	4	62	25
Convoys Wharf	4	26	17	4	34	25
Greenwich Pier	4	21	17	4	29	25
Greenwich Wharf	4	17	N/A	4	25	N/A
Victoria Deep Water Terminal	4	12	N/A	4	20	N/A
Proposed Bridge	4	0	N/A	4	8	N/A

Table 5.4 Bridge Opening Times Outbound Vessel (minutes)

Location	Bridge Lift Time (min)	Bridge Open Time (min) (7 knots ground speed)		Bridge Lowering Time (min)	Total Bridge Closure to Road Traffic Time (min)	
		Full Pilotage time – bridge open on departure	Adoption of abort approach - Layby at King George V Lock Entrance		No abort	With abort
Flidder's Reach	4	106	21	4	114	29
Queen Elizabeth 2 Bridge	4	91	21	4	99	29
Crayford Ness Limit	4	73	21	4	81	29
Pioneer Wharf	4	61	21	4	69	29
Ford Motor Jetty	4	49	21	4	57	29
Barking Creek Limit	4	31	21	4	39	29
King George V Lock Entrance	4	21	N/A	4	29	N/A
Thames Refinery (Tate & Lyle)	4	11	N/A	4	19	N/A
Thames Barrier	4	7	N/A	4	15	N/A
Proposed Bridge	4	0	N/A	4	N/A	N/A

Table 5.5 Bridge Opening Times Inbound Vessel (minutes)

5.1.4 Ship impact considerations

The proposed crossing is located at the upstream end of a 55 degree bend upstream of the Thames Barrier. Vessels from downstream will approach the bridge around the inside of this bend. Vessels approaching from upstream have a straight section channel of about 800m to align themselves with the navigable spans which should be easier to achieve.

The AASHTO guide includes a probability based analysis procedure for determining the annual frequency of vessel collision with bridges. This has been used in the PIANC Guide “Ship Collisions due to the Presence of Bridges” to estimate the collision risk of bridges on the Thames upstream of Tower Bridge.

For a 55° bend the correction factor for bridge location increases the risk of collision by a factor of 1.61 in the transition between the bend and the straight and by a factor of 2.22 if the bridge is located on a bend.

The proposed crossing location is located on the end of a bend of this magnitude and thus there is a significant increase in the risk of vessel collision with the bridge, than if the bridge was located on a straight section of river.

A previous study for an opening bridge on a similar bend considered the risk of an accident occurring for bridge spans of 100m, 200m and 300m. It estimated that there was an increased risk of collision of approximately 12% for a 100m over 200m span bridge and an approximate increase of 35% for a 100m over 300m span.

5.2 Aviation issues

London City Airport (LCA) is located approximately 1km to the east of the proposed new road crossing and 1.5km to the east of the proposed alternative footbridge location. For safe operation of the airport, restrictions are placed on developments in the vicinity. These safeguard zones are defined in published data which is available from LCA's website, which includes a note that the information may change without notice.

A copy of 'Safeguarded and Obstacle Limitation Surfaces – London City Airport' is included in Appendix 3 for information. It can be noted that the surfaces are more complex than those that were applicable when we reviewed the scheme in 2002. Drawings showing the safeguarded zones in relation to the proposed structure alignments are shown in Appendix 3.

The document from London City airport notes that all structures within the assessment area and higher than 45m above the lowest runway threshold (4.95m AOD) shall be referred for further investigation.

An assessment was undertaken, following the guidance described above, to determine if the proposed structures would impact on the safeguarded zones of the airport.

The results showed the footbridge on an alternative western alignment to be below the safeguarded surfaces, but within the area depicted for consultation and investigation.

The proposed road crossing and footbridge on the eastern alignment would be clear of the take off and approach surfaces but the towers of the bridge and top of the superstructure when in the raised position have the potential to infringe the Flight Protection Surface for Runway 28. The crossings are in the area depicted for consultation and investigation.

It can also be noted that LCA have historically stated an intention to object to high level bridge proposals at this location, and therefore it is considered imperative that structures should be kept below the protection surfaces.

5.3 Protected views

All of the bridge options will have towers or deck in excess of 50m in height, which equates to the height of a building 17 storeys or more. It is therefore necessary to consider the effect that the structure will have on any notable views as well the visual quality and aesthetics of the bridge itself.

Particular consideration should be given to the views discussed in the 'London View Management Framework' (LVMF), particularly the Designated Views. Two of the twenty six designated panorama views are located locally. Both are London Panorama Views. The first is split into two and is located adjacent to the General Wolfe statue in Greenwich Park and the other is at Blackheath Point, (see the Visual Appraisal Sheet 1 views 1, 2 and 3 in Appendix 4). The proposed crossings site area is at the eastern margins of these panoramic views and the crossings will visually impact on the viewing experience and should therefore be described in conjunction with the Management Plans as described in the LVMF. From a basic desktop study it would appear that the built environment of Canary Wharf blocks long distance views from the west although it could be that there is an impact on the background of the view from Alexandra Palace.

There are also a number of other significant views classified as Linear, River or Townscape Views.

Local views are relevant and should also be considered. (Some typical local views are shown on the Visual Appraisal Sheets 2 and 3 views 4 to 10 in Appendix 4).

The key to an acceptable visual impact will be the height, form and design quality of the overall structure and its visible component parts, taking local context into account. A new bridge has the potential to become a significant local, London or even national landmark which can define a place and become a cultural asset benefitting social, townscape character and visual amenity. The alignment and early decisions on height of the structure are as fundamental to these considerations as the beneficial impact of high quality bridge design.

5.4 Specific Environmental Aspects

In addition to the environmental constraints outlined in Chapter 4, and visual impacts noted above, there are several specific aspects relevant to the bridge options.

While traffic congestion would be relieved by the highway bridge options, higher noise levels and areas of poor air quality would be displaced through the redirection of traffic. Appropriate design considerations may therefore be necessary.

These include

- traffic management systems to smooth the flow of traffic
- the use of a carriageway surfacing material with lower noise properties
- the use of sound absorbent barriers

6 Highway alignments and associated constraints for bridge options

During a site visit the following existing constraints were identified as the most significant for bridge crossing options:

The O₂ Arena, North Greenwich Station, Jubilee Line Tunnels, QE2 Pier, DLR Viaduct, Nuplex / AkzoNobel Nippon Paint factory, and the Carlsberg Depot.

The study area comprises commercial and industrial properties.

The North Bank

During the site visit the A1020 Lower Lea Crossing / Silvertown Way roundabout was identified as the initial preferred location for proposed links to connect to the existing highway network in Silvertown.

The DLR viaduct running parallel to the northbound lane of the A1020 Silvertown Way effectively forces all options to remain south of Silvertown Way. A wider span was observed where the viaduct crosses over the access road from Dock Road to the vacant property located just north of the Carlsberg depot, therefore providing scope for a new route to cross below the viaduct structure. It is clear that vertical alignment for bridge options have to be brought down to ground level at this point to pass under the DLR if the road is to tie in with the existing highway network at the preferred location.

The Carlsberg depot and the Nuplex paint factory located just south of the larger DLR viaduct spans are further constraints to any alignments on the north bank of the river.

A mixed use development and a new consolidated wharf are planned at Thameside West which is immediately to the East of the safeguarded area.

The South Bank

Two piers on the south bank, the QE2 pier and the pier 200m north of John Harrison Way, may be affected if bridge crossings are proposed in their immediate vicinity.

The Millennium Way / Bugsby's Way roundabout is connected to the A102 Blackwall Tunnel Approach via existing slip roads and is therefore identified as the preferred location for proposed links to connect to the existing highway network in Greenwich.

There are plans for further mixed use development on the Greenwich Peninsula and it was noted during the site visit that two vacant properties north-west of John Harrison Way appear to be due to be developed in the near future. Any bridge options will have a significant impact on these properties.

6.1 Initial corridor alignments considered

Alignments within the protected corridor were investigated in the first instance. The protected corridor caters for bridges to cross the Thames over Bugsby Reach just south of the QE2 pier. The Silvertown Way roundabout and the Millennium Way / Bugsby's Way roundabout were identified as the preferred locations to connect in to

the existing highway network in Silvertown and Greenwich respectively. Main bridge piers were located equidistant from the centre of the navigation channel.

The maximum gradient applied to all bridges in this study is 5%. This is in accordance with pedestrian and cyclist standards and also to ensure safety on approaches to junctions following a long downhill gradient. This also limits the effect of heavy vehicles crawling uphill over a distance thereby slowing other traffic.

Using this horizontal alignment and maximum gradient, the vertical alignment for a low level lifting bridge (15m vertical clearance in lowered position) does not provide sufficient vertical clearance to pass underneath the DLR viaduct.

In addition, a desirable stopping sight distance may not be achieved along the small horizontal radius travelling northbound. Traffic is expected to have a higher speed following a downhill gradient of 5% for approximately 400m. It is concluded that this alignment incorporating a small horizontal radius together with a downhill gradient with reduced stopping sight distance is not a desirable solution. Drawings H001-LN01198-GDD and H002-LN01198-GDD in Appendix 5 illustrates the alignment and associated clearance issues.

Following discussion with TfL, an alternative alignment was investigated using a roundabout to replace the horizontal curve on the north bank. Drawing G008-LN01198-GDD in Appendix 11 refers. Applying DMRB guidance, roundabouts should be located on a flat gradient in the order of 2%. The investigation showed that creating such a platform for the roundabout does not alleviate the clearance issues.

Considering the vertical clearance issues and horizontal safety issues, associated with a 15m high bridge, further investigation on mid and high level bridges on this alignment were not undertaken.

It can be noted that previous studies, used for creation of the protected corridor, assumed a steeper gradient for the bridge approaches and bridge piers slightly offset from the centre of the navigation channel. In addition to issues of maximum gradient for pedestrian use, we consider any gradient steeper than 5% would be deemed unsafe by a highway safety auditor when taken in conjunction with the horizontal alignment and approaches to junctions. Examination of the exact alignments used in previous studies indicates similar issues with clearance to the DLR viaduct.

6.2 Alternative corridor alignments

6.2.1 Low-level and mid-level lifting bridge (15m and 25m vertical clearance respectively)

Alignments to the south of the protected corridor were investigated. These alignments increase the horizontal distance, thereby allowing for the change in level between the highest point of the bridge and the tie-ins to the existing highway networks.

The Silvertown Way roundabout and the Millennium Way / Bugsby's Way roundabout were again identified as the preferred locations to connect into the existing highway network in Silvertown and Greenwich respectively.

The initial idea was to cross the Thames in line with John Harrison Way. The horizontal alignment was, however, shifted slightly to the north to reduce impact on the property on the north bank. The pier on the south bank just north of John Harrison Way will potentially be affected. Both the Nuplex paint factory and the Carlsberg depot on the north bank will also be affected. Drawing H003-LN01198-GDD in Appendix 5 illustrates the proposed alignment for a single carriageway layout.

The vertical alignments for a low-level (15m vertical clearance in lowered position) are shown on drawing H005-LN01198-GDD. Western Parkside and Eastern Parkside Roads will need to be realigned to accommodate this option.

Our studies considered the maximum height of bridge that could be realised on this alignment based on desirable gradients and concluded that the limit is around 25m. The resulting vertical alignment for a mid-level lifting single carriageway bridge (25m vertical clearance in lowered position) is also shown on drawing H005-LN01198-GDD. No local roads in Greenwich need to be realigned for this option.

Both the low-level and the mid-level lifting bridge alignments are at ground level when crossing underneath the DLR viaduct thus providing sufficient vertical clearance.

Bridges higher than the mid-level lifting bridge with 25m vertical clearance cannot be catered for with this horizontal alignment. The increase in height is constraint by the tie-in to the Millennium Way / Bugsby's Way roundabout in Greenwich. If the tie in to the highway network on the south side of the river is moved, then the constraint becomes the DLR viaduct and a clearance of around 30m becomes possible. This arrangement has not been illustrated.

A dual carriageway arrangement has also been investigated for the mid-level lifting bridge with 25m vertical clearance. The alignments change slightly to allow for each carriageway to pass the piers of the DLR viaduct, but are essentially similar to those for the single carriageway layout and are shown on drawing H004-LN01198-GDD and H006-LN01198-GDD in Appendix 5.

6.2.2 Mid-level lifting bridge and high-level fixed bridge (35m and 50m vertical clearance respectively)

To cater for mid-level lifting bridges higher than 30m vertical clearance and fixed high level bridges with 50m clearance, alternative tie-in points beyond both Silvertown Roundabout and Millennium Way / Bugsby's Way Roundabout were investigated.

The horizontal alignment north of the river was extended to the north to tie-in to the A1261 / A1020 Lower Lea Crossing roundabout. The alignment south of the river was extended to the south to tie in to the A102 Blackwall Tunnel Approach south facing slip at Blackwall Lane. Drawing G004-LN01198-GDD in Appendix 11 illustrates the proposed alignment.

The vertical alignments for a mid-level lifting bridge (35 m vertical clearance in lowered position) are shown on drawing G005-LN01198-GDD in Appendix 11. This option will incorporate a 3.5km long viaduct. The vertical alignment shows that the southern limits of the option need to remain on a viaduct to provide sufficient vertical clearance crossing over the A102 Blackwall Tunnel Approach and the A2203 Blackwall Lane. The northern approach needs to remain on a viaduct to provide sufficient vertical

clearance crossing over the DLR viaduct, the A1020 Lower Lea Crossing and the Bow Creek / River Lea.

Further work is needed to realign the current southbound slip from Blackwall Lane onto the A102. An opportunity exists to relocate southbound traffic via Bugsby Way and Southern Way onto the A102. Further design development is also needed to investigate feasible solutions to reinstate the current accesses from the Lower Lea Crossing Roundabout to the Orchard Place on the Lower Lea peninsula. Detailed topographical surveys will be required.

Drawing G006-LN01198-GDD in Appendix 11 shows the vertical profile for a high level fixed bridge with 50m vertical clearance. This option will also incorporate a 3.5km long viaduct as for the 35m mid-level bridge. The only alignment difference between the 35m clearance mid-level lifting bridge and the 50m clearance fixed bridge is the height of viaduct over the river and on the immediate approaches to the river. The northern and southern limits of the viaducts are the same height as they have to clear the same constraints.

7 Highway Bridge options

Conventional bridge forms have been considered to assess the viability of the schemes. In each case a form of bridge has been chosen that will fit within the navigation and aviation clearances, and generally that has entailed using through bridges that minimise the depth from the carriageway to the bridge soffit. Preliminary designs were used to assess an initial construction depth, to which was added an allowance for rise in sea level. This figure was then used to prepare the vertical highway alignments.

7.1 Low level opening bridge

7.1.1 Proposed Structure

The form of bridge proposed, which is shown on Drawing No. S001-LN01198-NED in Appendix 7 comprises a low level viaduct with a central lifting span, providing a clear navigation width of 200 m, and an air draught of 15 m above Mean High Water Spring Tides (MHWST) when lowered, and 50 m above MHWST when raised.

The main span consists of twin bowstring girders, which are supported by twin towers at either end. The towers are supported on cellular caissons, which will provide resistance to shipping impact. The towers and the caissons contain all the lifting equipment that is required to raise and lower the main span.

The overall length of the structure, including the approach viaducts and the main span will be approximately 925 m.

7.1.2 Lifting Span

To provide a clear navigation span of 200 m, the main lifting span was established as 225 m. The lifting span consists of twin steel arches, tied at the lower level by the bridge deck to form a bow shape. The deck is supported by hangers, which connect the longitudinal tie beams, at deck level, to the arches.

Most structures of this type that have been constructed to date are of “through truss” form, with the road or rail traffic carried at bottom chord level, to minimise construction depth and height of lift. However, in order to provide a 200 m navigation channel, the span of the proposed structure, at 225 m is significantly longer than any truss lifting bridge that has been built. A truss bridge, of this span would be relatively utilitarian in appearance and a tied arch is proposed as being a more elegant solution, particularly considering the proximity of the bridge to Docklands and the O₂ site. A tied arch would have a comparable weight to a through truss, although it might be more expensive to fabricate. However maintenance costs should be lower because of the cleaner lines and fewer structural elements.

For a structure of this size, construction of the arches, longitudinal tie beams and cross beams in steel would be the only realistic option. Consideration has been given to alternative forms of deck slab construction. Two options have been considered, a reinforced concrete deck slab and a stiffened steel plate deck, however there is a significant difference in overall weight between the two options. The lighter weight steel deck would provide significant a significant cost saving for the lifting equipment and would minimise the operating power required. To further minimise the operating power, the bridge would need to be almost fully counterweighted. Both the structure weight

and the necessary counterweight would be minimised through the use of steel construction. Further weight savings can be achieved by using an aluminium deck, although this has not been studied at this stage.

7.1.3 Main Span Piers

The main piers would be of hollow reinforced concrete construction, and house the counterweight, lifting gear and operational control rooms. One pier at each end would be provided with a lift for operators or maintenance crews to reach the machine and electrical control rooms. The twin piers at each end of the main span would be supported on a large hollow reinforced concrete caisson. These would have sufficient mass to provide resistance to ship impact. Depending on a more detailed investigation into ground conditions, it is possible that a piled platform would be needed to support the structure. The caissons would house the machine room, electrical control room etc, which are required to operate the lifting span.

7.1.4 Approach Structure

To enable tie-ins to the existing highway network, both the northern approach structure and the southern approach structure would have to be curved in plan. To provide the necessary torsional stiffness, box girder approach structures (either steel or post-tensioned concrete) are proposed. This form of structure could be locally strengthened to meet the collision criteria defined for the side spans over the river.

Once the river banks have been reached, the approach spans could be progressively reduced to more economical span lengths, in the range of 40 – 50 m.

Reinforced concrete piers on piled foundations are considered appropriate in this location.

7.1.5 Approach Span Abutments

The abutments to the approach structures would have heights of around 5 m. It is proposed that the ends of the deck are supported on piled reinforced concrete walls, with earth retaining wing walls running back parallel to the approach roads to minimise land take

Reinforced earth is an economical form of construction for retaining structures for heights of up to 8 – 9 m. and is therefore proposed for the wing walls.

7.1.6 Lifting System

It is intended that the bridge can be raised and lowered by a steel cable system incorporating four winches, one in each of the four main span towers.

Plant rooms are proposed inside the caissons at the base of the main piers, which will accommodate all the mechanical and electrical equipment that is required to raise and lower the bridge.

7.1.7 Control and Monitoring

The operating system could be controlled from a single console mounted in one of the towers. Road traffic and pedestrian control would be by a conventional system comprising lights, audible warnings and road and pedestrian barriers. Navigation lights

would control river traffic. These provisions would be electrically interlocked with the bridge control system.

7.1.8 Construction Methodology

The method of construction of this bridge would require no new technology or unproven techniques. All operations, whilst often of large scale, are practical and relatively straight forward. All construction activities in the river would present some obstruction to river traffic, principally from floating plant, and it would be necessary to agree any restrictions with the PLA in advance. It might prove necessary to stage the work (for example by constructing only one pier caisson at a time) to limit the temporary obstruction of the waterway. It would also be necessary to arrange for one complete closure of the navigation channel for a two day period when the main lifting span was brought to site and erected into position. The date of this closure, and any contingency dates could be published months, if not years, in advance to minimise their impact on river traffic.

7.2 Mid level opening bridge

The form of bridge proposed (which is shown on Drawing No. S002-LN01198-NED in Appendix 7 for a single carriageway bridge, and on Drawing No S002-LN01198-NED for a dual carriageway bridge), comprises a mid level viaduct with a central lifting span, providing a clear navigation width of 200 m, and an air draught of 25 m or 35 m above Mean High Water Spring Tides (MHWST) when lowered, and 50 m above MHWST when raised.

The general form of main span and approach structures is identical to that proposed for the Low Level Lifting Bridge. Similarly the lifting system and the control and monitoring procedures will be as proposed for the Low Level Lifting Bridge.

Two alignments have been considered for the Mid Level Lifting Bridge. The first is the same as the alignment proposed for the Low Level Lifting Bridge. The overall length of the structure, including the approach viaducts and the main span will therefore be the same as the Low Level Lifting Bridge, at approximately 925 m. The only difference will be the pier heights. The air draft for this bridge in this location is 25m. As noted in section 6.2.1 of this report, the draft can be increased to around 30m by modifying the tie in point to the existing highway.

The second alignment is the same as proposed for the High Level Fixed Viaduct, and it is possible to provide an air draft of 35m or more on this alignment. This will result in a much longer overall length of structure. The opening bridge itself would remain the same as that proposed for the low level bridge.

7.3 High level fixed bridge

7.3.1 Proposed Structure

The form of bridge proposed, which is shown on Drawing No. S003-LN01198-NED comprises a high level viaduct with a fixed central span, providing a clear navigation width of 200 m, and an air draught of 50 m above Mean High Water Spring Tides (MHWST).

A cable-stayed structure is proposed for this bridge. The height of the towers is restricted by the aviation clearance envelope. Variations on cable stayed towers are possible e.g. inverted triangular supports, when viewed in elevation from the river. However, the option proposed provides the minimum possible span length over the 200 m wide navigation channel and probably the most economical form of construction.

A steel/concrete composite deck is shown on the drawing included in this report, although an all steel deck would be lighter in weight, which may be beneficial for tower and cable design. On the other hand, the composite deck may provide a more robust durable solution. Final choice of deck type would require further investigation, should the high level fixed crossing prove to be a viable solution.

Other forms of structure, which have been considered, are as follows: -

- Box Girder Bridge
- Suspension Bridge
- Calatrava Arch

The box girder bridge would be of either steel or post-tensioned concrete construction. The deck would be of variable depth, with a haunched soffit. To maintain navigation clearance over the whole channel, the main span length would need to be increased from that proposed for a cable stayed bridge (225 m), as the structural depth at the ends of the span would be greater. It is anticipated that there would be no construction cost advantage.

For a medium span bridge, the suspension bridge is unlikely to be more cost effective than the cable stayed bridge, although aesthetically either option may be acceptable.

The Calatrava Arch solution is an aesthetically pleasing option, but would require a much longer span, for the same navigation envelope, and is not likely to be cost effective.

Should the high level crossing prove to be a viable option, then further investigation will be required into the aesthetics of the entire bridge and approaches.

7.3.2 Main Span Piers

The main towers are "A" frames constructed from either steel or concrete. A more elegant single tower solution, with all the cables in one plane, may also be possible. However, with the relatively low height towers and without the benefit of detailed structural analysis, it is considered that the feasibility of this solution would require further investigation.

7.3.3 Approach Structure

The approach structures, including abutments will be similar in construction to those proposed for the Mid Level Lifting Bridges, but of greater height and much greater extent.

7.3.4 Construction Methodology

Foundation and tower construction would be no different, in principle, to that proposed for the lifting bridges. The navigational constraints would therefore be similar.

Proven techniques could be used for deck construction. This would involve segmental construction, with the deck built progressively as balanced cantilevers from each tower. Deck segments could be transported on barges and lifted into position from the partially completed deck above. Construction activities in the river would therefore present some obstruction to river traffic, principally from floating plant, and it would be necessary to agree any restrictions with the PLA in advance.

8 General Design considerations relevant to tunnel options

8.1 General

Road tunnels are probably more difficult to construct than bridges and certainly require more specific operation and maintenance procedures. They now have a strict regulatory environment for design, operation and maintenance as set out in the Road Tunnel Safety Regulations 2007 (refer 8.2 below).

However a road tunnel, once built, can offer the most convenient form of river crossing for vehicular traffic. It offers no further obstruction to navigation, only minor visual intrusion created by the approaches and in general operation is not subject to weather conditions. For river and estuarial crossings, where typical hinterland development has created major transport arteries close to and parallel to both banks, a tunnel will usually offer the shortest crossing. This is because draught requirements for shipping (channel depth below low water) are normally much less than the required navigational clearance above high water (air draught). A tunnel approach therefore has to fall much less than a bridge has to climb (unless navigation is partially restricted e.g. by a lifting bridge) and can therefore be shorter. Thus connection to shore side infrastructure can be achieved more easily.

8.2 Regulatory Background

The design requirements for road tunnels in the UK have for some time been set out in BD78/99 Design of Road Tunnels¹. Following loss of life in fires in several European road tunnels, an EU Directive² was introduced setting out minimum safety requirements for road tunnels. This Directive has subsequently been enacted into UK law by means of the Road Tunnel Safety Regulations 2007 (RTSR)³ which adopt the EU Directive with some additions and clarifications to meet UK legislation and practice. BD78 is being revised to make it consistent with RTSR but has not yet been published.

It should be noted that RTSR applies to tunnels 500m long (between portals) and to tunnels on the Trans-European Road Network (TERN). Whilst the tunnel options proposed in this Report will qualify on length (i.e. they are >500m long) they are emphatically not on the TERN i.e. they are intended to be local, not regional or strategic, routes. However the Highways Agency does regard the EU Directive as a manual of good practice which, in its view, should be followed unless it is not cost-effective to do so. There are some instances where the EU Directive may not be cost-effective and these are addressed below.

8.3 Navigation

From the Port of London Hydrographical Service chart, there is a clearly defined dredged channel with a depth below Chart Datum (low water) of approximately 6m. *[Chart Datum (CD) is 3.35m below Ordnance Datum (OD): for clarity all further references to levels in this Report will be against Ordnance Datum]*. Channel bed level has therefore been taken as -10.00m OD for the purpose of conceptual tunnel layouts.

8.4 Specific Environmental Aspects

In addition to the environmental constraints outlined in Chapter 4, there are several specific aspects relevant to the tunnel options.

The tunnel option will require a significant amount of excavated material to be removed. Given the high likelihood of contamination of the area, the treatment of the material may be time consuming and costly. The tunnel option also has the greatest potential to encounter archaeological remains.

The tunnel option would result in high noise pockets and concentrated areas poor air quality at the tunnel approaches due to the inability for the emissions to disperse.

However, the visual impact is likely to be significantly less for the tunnel option than for the bridges,

8.5 Gradients

RTSR requires that new tunnels should not have gradients steeper than 5% "unless no other solution is geographically possible." In tunnels with gradients steeper than 3%, a risk analysis is required to determine any measures needed to enhance safety.

Steep gradients cause Heavy Goods Vehicles to slow down and increase their emissions. This reduces tunnel capacity and increases ventilation requirements. In this Report we have considered alternative gradients of 4% and 5%.

Flood Protection

Critical tide and flood protection levels are shown in Table 8.1:

Table 8.1 Critical Tide and Flood Protection Levels

<i>Tidal State or Flood Level</i>	<i>Level mOD</i>	<i>Comments</i>
<i>Mean High Water Spring Tides</i>	<i>+3.7m</i>	<i>varies slightly with location up or downstream</i>
<i>Highest Recorded High Water</i>	<i>+5.18m</i>	<i>(increases with storm surge)</i>
<i>General flood protection level upstream of Thames Barrier</i>	<i>+5.3m</i>	<i>From OS mapping</i>
<i>Downstream of Thames Barrier Flood Containment Level</i>	<i>+7.2m</i>	<i>based on 1 in 1,000 year flood risk at year 2030 river level</i>

On the Northern and Southern Corridor Alignments between Greenwich Peninsula and Silvertown (Alignment A1, A2/1, A2/2), ground levels are of the order of +4mOD to +5mOD. Ideally, the tunnel road profile would climb to approximately +6mOD before descending to meet local road infrastructure to create a “flood hump”. This together with surrounding parapet walls would create passive flood protection to the tunnel entrances to seal the tunnel against high tide levels. The original options allowed for such a flood hump. However, since the area is protected by the Thames Barrier subsequent studies have considered alignments with no specific protection. This would be subject to a detailed risk assessment at a later stage, to consider the likelihood and consequences to the tunnel of a breach in the flood protection system.

On the alignment downstream of the Thames Barrier (Alignment B1), ground levels immediately adjacent to the river are lower, of the order of +3m OD, rising to +6m OD further from the river. Again, flood protection level afforded by the Thames Barrier and surrounding river walls is taken as adequate, so that for this tunnel there is no allowance for additional flood protection. Again, this would be subject to a detailed risk assessment at a later stage.

During construction of immersed tube tunnel options it will be necessary to demolish the river defence walls in order to create access for the tunnel elements. Prior to such demolition, temporary defence walls will be constructed as part of the temporary works process to ensure that there is no increased flood risk. On completion of the tunnel, the permanent river defence walls will be reconstructed on top of the tunnel structure.

It should normally be possible to construct the bored tunnel underneath the existing walls without disturbing them; however this will depend on the depth and nature of the wall foundations.

These issues, including particularly the flood risks will be reviewed in more detail at the feasibility stage of the design.

8.6 Fire and Life Safety

RTSR is very much concerned with creating a safe environment in tunnels in the event of a fire or other situation. Depending on their size and importance (as measured by length and traffic flow) tunnels are required to be provided with facilities and systems to:

- prevent, detect and fight fire
- enable communication with users by means of rebroadcasting and emergency telephones
- provide emergency exits and protected means of escape to the open air
- provide emergency stopping lanes and/or walkways
- provide fire resistance to the tunnel structure and equipment
- provide lighting and signing for both lane control and emergency escape

These issues will be dealt with in specific detail for each tunnel option in Section 10 below. However they are noted in general here because of the influence they have on the tunnel cross section, particularly where there is only a single tunnel bore containing 2-lanes of traffic.

8.7 Cross Section

The tunnel cross section will be based on BD78/99 Figures 4.1 and 4.2 depending on the type of tunnel and the dimensions will be determined by:

Horizontal

- Lane width in accordance with TD27⁴ - typically 3.65m.
- Hard strips - according to BD78 provision is subject to cost benefit study - in this case there are issues relating to off carriageway provision for emergency lanes to be taken into account.
- Side verges (walkways) - a minimum side verge of 1m each side is required with a kerb height of 0 to 75mm to facilitate opening a car door. Verges are now low level to avoid users shying away from them and to facilitate access to emergency facilities by the disabled. The verge must provide a horizontal width of 600mm measured from the kerb with full headroom (refer equipment gauge below).
- Emergency exit and escape passage - RTSR requires the provision of emergency exits in a new tunnel with traffic flow > 2,000 vehicles/lane/day. Emergency exits must lead to a place of safety i.e. cross connection between tunnel tubes (in a dual 2-lane cross section), an emergency gallery or direct connection to the outside. Since there is no parallel tube in a single 2-lane tunnel, an emergency gallery with access either to the tunnel portal or to the surface (via enclosed stairs) must be provided.
- Pedestrian usage - BD78 regards use of a road tunnel by pedestrians as "exceptional". It suggests the use of a raised guarded walkway (separate from the low level walkway for emergency use or consideration of a partitioned passageway with separate ventilation. Although a separate escape passage could serve also as a pedestrian walkway, the two would be better separated so that there is no possibility of pedestrians straying into the vehicle tunnel either accidentally or deliberately.

Vertical

- Traffic clearance - all equipment in a road tunnel must be placed outside the equipment gauge. The equipment gauge is determined by the traffic gauge (maintained headroom of 5.03m) plus an additional allowance of 0.25m to protect soft equipment (luminaires and signage) from compressible loads (i.e. those which may increase in height after passing through height detection), flapping tarpaulins etc.
- Equipment space - clearance above the equipment gauge is provided to accommodate luminaires, signs and signals and cameras and provision for ventilation either as ducts or fans. *For these tunnels we have allowed 0.5m generally for luminaires, signs, signals and cameras and an additional 1.0m to accommodate fans in localised niches in the roof.*
- Space below the roadway in a bored tunnel cross section may be filled in or by supporting the road on a suspended slab, used for ventilation, drainage or cabling

9 Highway alignments and associated constraints for tunnel options

The original brief for this part of the Study covered single duct 2-lane tunnels within the general area of the North Greenwich – Silvertown Protected Corridor. Because of the limitations (and to some extent inefficiency) of a single 2-lane tunnel, the Study has been expanded to cover dual 2-lane tunnels as well. The Study Area was also expanded to cover possible alignments in the vicinity of the Thames Barrier.

Within the Study we have developed conceptual cross sections for single 2-lane and dual 2-lane immersed tube tunnels and a single 2-lane bored tunnel. [It is not normally possible to accommodate 4 lanes within a single bored tunnel but a dual 2-lane bored tunnel arrangement could be developed from twin parallel bores if required.] The traffic provisions and fire life safety implications of these are reviewed.

Trial horizontal and vertical alignments at three locations have been developed and tested for feasibility. The primary controlling factor is the horizontal distance necessary for road level within the tunnel structure to provide the necessary navigational clearance in the river and then rise to connect to existing infrastructure. This has been tested at gradients of 4% (preferred) and 5% (desirable maximum) and in one case at 6%. A summary of locations and feasible options is given in Table S1.

Table S1 Summary of Alignments

Location	Alignment Option No/Name	Tunnel Type	Max Gradient	Comments
North Greenwich to Silvertown Protected Corridor	A1 Northern Corridor Alignment	Immersed Tube	6%	Only geometrically possible using 6% gradient on Silvertown entry/exit
South of Protected Corridor	A2/1 Southern Corridor Alignment	Immersed Tube	5%	Also practical at 4%
South of Protected Corridor	A2/2 Southern Corridor Alignment	Bored Tunnel	5%	Not geometrically possible at 4%
Thames Barrier	B1 Thames Barrier Alignment	Immersed Tunnel	5%	Other options not tested

During a site visit on 11 March 2009 the following constraints were identified as the most significant for tunnel crossing options in the original study area:

The O₂ Arena, North Greenwich Station, Jubilee line tunnels, QE2 Pier, DLR Viaduct, Nuplex / AkzoNobel Nippon Paint factory, Carlsberg Depot.

It was observed that the study boundaries fall within an urban area that comprises of commercial and industrial properties.

The North Bank

The A1020 Lower Lea Crossing / Silvertown Way roundabout was identified as the initial preferred location to connect to the existing highway network in Silvertown.

Jubilee line tunnels running from North Greenwich station towards the Bow Creek / River Lea constrain tunnel options in that area.

The DLR viaduct running parallel to the northbound lane of the A1020 Silvertown Way effectively forces all options to remain south of Silvertown Way. A wider span was observed where the viaduct crosses over the access road from Dock Road to the vacant property located just north of the Carlsberg depot. This provides scope for a new route to cross below the viaduct structure. It is clear that the vertical alignment cannot be higher than ground level at this point. Flood humps on northern approaches for tunnel options may therefore conflict with the DLR viaduct.

The Carlsberg depot and the Nuplex paint factory located just south of the larger DLR viaduct spans are further constraints to any alignments on the north side of the river. A mixed use development and a new consolidated wharf are planned at Thameside West which is immediately to the East of the safeguarded area

The south Bank

The Millennium Way / Bugsby's Way roundabout is connected to the A102 Blackwall Tunnel Approach via existing slip roads. It is identified as the preferred location for proposed links to connect to the existing highway network in Greenwich.

There are plans for further mixed use development on the Greenwich Peninsula and it was noted during the site visit that two vacant properties north-west of John Harrison Way appear to be due to be developed in the near future. Any tunnel options may have a significant impact on these properties.

A site visit was undertaken to the new study area near to the Thames Barrier on 13 May 2009.

The Holborn College in Woolwich is located just east of the A206 Woolwich Roundabout on the south bank. An industrial estate of old warehouses is situated north of the A206. Some of the warehouses seem to be vacant. A residential estate borders the industrial estate on the eastern side.

Apart from a portion of undeveloped land northwest of the A1020 roundabout, the Connaught Bridge and London City Airport together with the Royal Victoria and Royal Albert Docks restrict any alignments further north of the A1020. In addition, the DLR viaduct that runs parallel to the westbound A1020 forms a constraint to the north.

9.1 Alignments considered

One possible option for a tunnel crossing is a third Blackwall Tunnel bore in between the two existing tunnels. This alignment is reviewed separately in section 10.5 below.

9.1.1 Northern Corridor Alignment (A1)

The Northern Corridor Alignment (see Drawing H007-LN01198-GDD for the single carriageway and H011-LN01198-GDD for the dual carriageway in Appendix 5) follows the original Protected Corridor between a new connection to Millennium Way, just south of North Greenwich Station, to the existing roundabout on the A1020 Silvertown Link. It crosses under the DLR Extension viaduct via the access of the two lengthened spans provided for that purpose. The alignment follows a constant radius of 1,000m in plan. Whilst this requires the tunnel to be curved, it avoids sharp alignment changes on the Silvertown side which would otherwise be necessary with a straight tunnel crossing. The radius is sufficient to avoid sightline widening in the tunnel.

Vertical alignment is different for bored and immersed tube tunnels and will be discussed under Tunnel Options below. Whilst the Northern Corridor alignment provides the most direct crossing route, it is too short to allow any tunnel option to achieve sufficient depth to meet both navigational constraints in the river and limiting highway gradients. However, by increasing the Silvertown entry / exit gradient to 6%, an immersed tube tunnel can be made practical at this location. Alternatively the design speed could be reduced to allow a smaller radius to the horizontal curves, thus giving a slightly longer alignment and shallower gradient. Neither alternative is ideal.

The 6% gradient exceeds the desirable maximum of 5% stated in RTSR 2007. (see section 10.6 below) The New Tyne Crossing is being currently being constructed with a 6% entry gradient (the new tunnel will carry 2 lanes of southbound traffic only; the existing tunnel will be retained to carry 2 lanes of northbound traffic). A steep entry gradient is somewhat less of an issue than a steep exit gradient since the latter slows down heavy vehicles and reduces capacity. The effect will be reduced in the dual 2-lane tunnel since one lane can become a quasi-crawler lane when necessary, with lighter traffic free to use the second overtaking lane.

9.1.2 Southern Corridor Alignment (A2/1, A2/2)

The search for a longer crossing led to the Southern Corridor Alignment (see Drawing H009-LN01198-GDD for the single carriageway and H012-LN01198-GDD for the dual carriageway in Appendix 5). This starts from the existing roundabout at the junction between the A102(M), Millennium / Bugsby's Way and John Harrison Way. It crosses the River, again on a curved alignment of 1000m radius, making a landfall on the East side of the River on the Excel car park site. It then traverses the two industrial sites before crossing under the DLR Extension at the same point as the Northern Corridor.

This alignment does have sufficient length to accommodate an immersed tube tunnel alignment (Alignment A2/1) at approach gradients of 4% or 5%. It can also accommodate the greater depth of a bored tunnel (Alignment A2/2).

It should be noted that, although these are tunnel alignments, both bored and immersed tube tunnel options will be in cut and cover tunnel approach tunnel or ramp where they cross the two industrial sites. Acquisition and clearance of these sites is therefore a prerequisite of these route options.

9.1.3 Thames Barrier Alignment (B1/B2)

Alignments near to the Thames barrier were added to the study. The favoured alignment in this area is Alignment B1, (see Drawing H014-LN01198-GDD in Appendix 5). It starts from the A206 Woolwich Road roundabout opposite Charlton Park, crosses the river again on a horizontal radius of 1,000m and terminates at the existing A1020 North Woolwich Road roundabout. There is no difficulty in fitting this alignment at gradients of 5%.

An extended version of this alignment (see Drawing G016-LN01198-GDD in Appendix 11) continues to a new roundabout located northwest of the existing A1020 North Woolwich roundabout. This alignment crosses below the DLR viaduct that runs parallel to the A1020 and provides the scope to include floodwalls if required.

There are other possible alignments just west of the Thames Barrier but these have not been developed following advice from TfL. (see Drawings G020-LN01198-GDD and G022-LN01198-GDD in Appendix 11).

10 Tunnel options

10.1 Tunnel Types

Two tunnelling techniques lend themselves to underwater crossings: immersed tube tunnels and bored/driven tunnels. A third method, cut and cover tunnelling, requires extended work in the River itself, necessitating marine traffic management and navigation restrictions which are likely to be unacceptable to the Port of London Authority.

- *An immersed tube tunnel is one in which precast concrete elements, accommodating the full tunnel cross section are placed end to end and jointed to form a continuous tunnel. The elements, typically around 100m long are prefabricated in a casting basin below river level, floated to the tunnel site and sunk into position in a pre-dredged trench. The tunnel is then backfilled to the level of the original, or future, river bed. Rock armour protection is laid to prevent damage by stranding ships or dragging anchors. Typical cross sections of immersed tube tunnel suitable for a single 2-lane highway (based on the New Tyne Crossing, currently under construction) and a dual 2-lane highway (based on other recent tunnel projects) are shown in Drawings T001-LN01198-GDD and T008-LN01198-GDD in Appendix 8. The sections are rectangular and can be tailored to fit the functional spatial requirements of the tunnel with little wasted space.*
- *A driven, or bored, tunnel is a tunnel excavated underground, usually from a vertical access shaft without other surface access. In soft ground such as exists at this site, such a tunnel is typically driven by a tunnel boring machine (TBM) which would start in an access shaft at one end and drive continuously through to the other end (on larger multi-lane tunnels, more than one TBM might be used but this is unlikely for a bore such as this). Bored tunnels are generally circular in cross section as illustrated in Drawing T004-LN01198-GDD which is based on one bore of Dublin Port Tunnel, recently completed in Ireland. The section is circular for structural strength which can lead to some wasted space. Segmental space under the roadway can be used for utilities or, in the case of Dublin Port Tunnel, has been filled in. Space above the roadway is used for signs, lighting and ventilation.*

For the derivation of traffic and equipment gauge dimensions for these sections refer to 10.6.4 below.

Both types require approach tunnels and ramps where bored or immersed tube methods are not possible for reasons of inaccessibility or low cover. In congested urban conditions, these tunnels and ramps are usually constructed by cut and cover methods utilising vertical earth support from combinations of sheetpiles, secant pile walls or diaphragm walls. A typical section of a cut and cover tunnel in diaphragm wall is shown in Drawing T002-LN01198-GDD in Appendix 8. A similar section without the roof slab would be used for open approach ramps.

10.2 Geotechnical Conditions

Only outline geotechnical information is available at sites either side of the Study Area including Blackwall Tunnel and Gallions Reach. New information from JLE has not been obtained in time to be of use for this short study.

The geotechnical succession assumed at the site of the Southern Corridor Alignment is shown on Drawing G009-LN01198-GDD in Appendix 6. It consists of:

- Made ground at the river banks approx 5m thick
- Alluvium at variable thicknesses between 2m and 8m
- Terrace Deposits 6m – 12m thick
- London Clay about 4m thick
- Woolwich and Reading Beds

There are several layers of the Woolwich and Reading beds containing laminated sands and silts, lower shelly and mottled clays and pebble beds and glauconitic sands.

An immersed tube tunnel would be founded at its deepest in the top of the Woolwich and Reading Beds. As the tunnel climbs to the landfalls it would be constructed in London Clay, Terrace Deposits and some alluvium. Since an immersed tube exerts very low bearing pressures by virtue of its inherent buoyancy, the main concern is stability of the dredged trench. This is unlikely to be a problem in these materials.

The Blackwall Third Crossing Report⁵ refers to the role of the London Clay in preventing downward migration of mobile contamination from the soil to the aquifer below and the consequent undesirability of the immersed tube penetrating that layer. Given the limitations of the geotechnical data available at this stage, it is impossible to say whether or not this would be the case. If it did, then the implications would have to be assessed.

At its deepest a bored tunnel would be constructed within the Woolwich and Reading Beds. As it climbed to landfalls it would pass through London Clay and the Terrace Deposits. This is mixed ground for tunnelling but would be generally similar to the conditions for the Blackwall Tunnel bores. It must be regarded as higher risk construction than the immersed tube tunnel.

10.3 Effects on Vertical Alignment

10.3.1 Tunnel Depth

The immersed tube tunnel is backfilled into an open trench. Road level at the lowest point is calculated from:

Navigation depth	-10.0m AOD
Depth of rock armour	1.5m
Height from base of armour to road level	6.7m approx
Road level at deepest point	-18.2 m AOD

The bored/driven tunnel is typically placed up to 1 x tunnel diameter below lowest river bed level. In this case we have assumed a depth of half the tunnel diameter (6m) based on tunnelling experience for JLE. This must be regarded as minimum cover. Hence

Lowest river bed level	-10.85m AOD
Depth to top of tunnel bore	6.0m
Height from top of tunnel to roadway	7.45m
Road level at deepest point	-24.3 m AOD

10.3.2 Road Gradient

RTSR recommends road gradients not exceeding 5%. We have used alternative gradients of 4% and 5% and up to 6% in one case. Vertical curve lengths appropriate to a 40mph design speed were used.

10.3.3 Vertical Alignment Constraints at Landfalls

10.3.3.1 Alignments A1, A2/1 and A2/2

It is understood from the Blackwall Third Crossing Report⁵ (and demonstrated from OS mapping) that flood defence walls upstream of the Thames Barrier are maintained at about +5.2m OD (refer Table 8.1) to protect adjacent low-lying land.

Ground level at landfalls on the two sides of the river is typically +4m OD behind the river walls rising to +5m OD inland.

10.3.3.2 Alignments B1 and B2

Flood protection walls downstream of the Thames Barrier are maintained at +7.2m OD (refer Table 8.1). Ground levels in this area immediately behind the flood protection walls is approximately +3m OD rising to +5m OD or +6m OD with distance from the river.

10.3.4 Vertical Alignment

Vertical alignments included in Appendix 5 derived from these constraints are illustrated as follows :

Drawing H008-LN01198-GDD	Northern Corridor Immersed Tube Tunnel A1
Drawing H010-LN01198-GDD	Southern Corridor Immersed Tube Tunnel A2/1
Drawing H013-LN01198-GDD	Southern Corridor Bored Tunnel A2/2
Drawing H015-LN01198-GDD	Thames Barrier Tunnel B1

It can be seen that for the Northern Corridor (Alignment A1) it is only possible to achieve landfalls at existing ground levels by applying a gradient of 6% to the Silvertown entry/exit. Whilst this exceeds the desirable maximum of 5%, it does enable a tunnel on this protected route. A bored tunnel alignment has not been drawn since this starts from a lower level than the immersed tube (and therefore requires a longer length to achieve tie-in level at the same limiting gradient.

For the Southern Corridor (Alignment A2) an immersed tube tunnel at gradients of 5% can achieve a landfall at existing ground level. An immersed tube tunnel at 4% and bored tunnels at 4% and 5% (Alignment A3) can also be achieved on this alignment.

For the Thames Barrier Alignment B1, satisfactory vertical alignments can be achieved at 5% gradient.

10.4 Preferred Tunnel Options

For each tunnel, approximate interfaces between immersed tube (or bored tunnel) construction and approach tunnels and approach ramps have been shown on the drawings.

For the immersed tube this interface would be located about 20m into each bank. This allows space for a cofferdam (or transition structure) within the shelter of the bank and therefore less vulnerable to ship impact.

For the bored tunnels, the interface is based on an approximate interpretation (at this stage) of the ground conditions and cover which would dictate termination of bored/driven tunneling. Deep shafts would be required to establish the TBM drive at one end and remove it again at the other. The shafts would also provide the transition between bored and cut and tunnels.

Typically the portals are sited so that they have about 2m cover over the structure. This allows adequate depth for utilities and drainage trenches to be excavated over the top of the tunnel and also allows landscaping to be established over and around the portals. The portal headwall would be extended into parapet walls along the top of the open ramp structure; these act as vehicle or pedestrian barriers for adjacent surface roads but more importantly in this case as flood protection walls.

For Alignment A1 only the portal has been extended so that the tunnel emerges from the northern side of the DLR embankment to minimise severance of the area in future.

The transition from structural open ramp i.e. U-sections, to open cut is again very dependent on ground conditions and particularly groundwater levels and permeability. Again the locations shown are approximate.

The drawings of the immersed tube tunnel sections show an immersed tube length between 519m and 592m. This length is likely to be made up of six tunnel elements (which would vary in length between 86.5m and 98.7m) but the final element length will be determined by the availability of casting basins and hydraulic studies in the river

Drawing H013-LN01198-GDD shows a bored tunnel longitudinal section. Assuming that bored tunnel construction was possible within the Terrace Deposits, the bored tunnel itself would be 656m long with another 106m of cut and cover tunnel at the

Greenwich end and 148m at the Silvertown end, total length about 910m between portals

10.5 Blackwall Tunnel 3rd Bore

In the 10-15 year period prior to the 1996/7 Blackwall Third Crossing Study⁵, severe congestion at peak periods and overheight vehicle problems in the northbound tunnel led to consideration of replacement or supplement of the northbound tunnel by a new modern standard third bore. Initially, abandonment of the old tunnel was proposed, subsequently options were developed which considered the northbound tunnel in conjunction with:

- a west spur; aimed at provision of a direct link from Greenwich to the Isle of Dogs/Canary Wharf development, but ongoing development had virtually ruled this out even by 1996.
- use solely as a public transport corridor; and
- an east spur option, still considered feasible in 1996 albeit with cost and social disadvantages.

A number of "three tunnel" scenarios, based on the east spur option, were therefore tested in a 1997 Technical Paper on Engineering and Operational Feasibility⁶:

- Option 1 retaining connection of the existing northbound tunnel to the A102 with the third tunnel used for 2-way operation by HGV/overheight vehicles only.
- Option 2 sought to use the third tunnel for all northbound traffic, retaining (then) existing connections to the A13 and Cotton Street. The existing northbound tunnel would become a 2-way local link but connections to the local road network proved impractical.
- Option 3 utilised the existing northbound tunnel and then recent A102/Cotton Street improvement, converting both to 2-way flow. The third tunnel would connect directly into A102 with amendment of existing slip roads.
- Option 4 was a variant of Option 3 intended to reduce traffic impact on the A13/Cotton Street junction.

None of the options provided improved access to Docklands since they did not improve or avoid the then current Cotton Street or Prestons Road Roundabout capacity problems. Option 3 which removed turns from A13 into Cotton Street was considered to reduce accessibility to Docklands. All had significant environmental impact and Option 2 caused major traffic intrusion into residential areas.

The conclusion of the Paper was that none of the options considered should be taken forward for further study and this conclusion was reiterated in the main Report⁵.

The twelve years since this latter Report may have seen significant changes in the area but the extent of study required to establish this is not within our current brief. However the geometrical difficulties of connection to a third bore will have remained unchanged and it seems unlikely that either the traffic congestion or sensitivity to environmental impact on residential areas will have in any way reduced.

10.6 Fire Life Safety in Tunnels

10.6.1 Regulatory Background

As introduced in Section 8.6, fire life safety requirements for tunnels are specified in BD78 and RTSR according to length and traffic flow.

For the purposes of this section, the tunnel length between portals has been taken as 910m., approximating to the longest (bored tunnel) option. No traffic flows are available but we have assumed that the tunnel would run at capacity equivalent to a range of 1,500 to 2,000 vehicles / lane / hour, equivalent to Annual Average Daily Traffic (AADT) of 15-20,000 vehicles.

From BD78 Figure 3.1 the tunnel is Category B (marginally Category A at the higher end of the traffic range) and requirements are specified in BD78 Table 3.1 (there is no difference in basic provision between Categories A and B) of BD78.

From RTSR, all tunnels >500m are included (with proviso regarding the TERN as already mentioned) and additional provisions apply where flows exceed 2,000 vehicles/lane/day (<<1,500 - 2,000 veh/hr).

10.6.2 Tunnel Ventilation and Smoke Extraction

With the continuing reduction in vehicle emissions as a result of the ongoing EU vehicle emission legislation, the requirements for ventilating the tunnel during normal operation are much reduced from tunnels designed and built in earlier years. However the recent fatal fires in road tunnels have emphasised the need to provide effective emergency ventilation and other facilities in road tunnels, particularly those with bi-directional traffic operation.

Strictly according to RTSR, this tunnel does not require mechanical ventilation system since it is less than 1,000m long. However traffic flows are far higher than the lower traffic limit proposed under RTSR (ie 2,000veh/day/lane). Consideration of the factors in RTSR Art 2.91 (control of vehicle pollutants under normal and peak hour traffic flow, control of vehicle pollutants when stopped due to an incident or accident and control of heat and smoke in a fire) leads to the desirability of provision of some mechanical ventilation in a tunnel of this length.

Further in tunnels with bi-directional traffic and /or congested uni-directional traffic, where a mechanical ventilation system is required, it must be transverse or semi-transverse with provision for smoke extraction local to a fire; this requires a duct with dampers.

However, longitudinal ventilation may be permitted if a risk analysis can demonstrate that it is acceptable using mitigation measures if necessary, such as decreased spacing between emergency exits, traffic management or smoke extraction at intervals.

The provision of a 2-way flow single bore tunnel to accommodate full height HGVs would, under RTSR, require a quantitative risk analysis (QRA) to establish the safety requirements appropriate to the traffic type and level, the level of tunnel supervision and other site-specific conditions.

There are therefore two ventilation options that are applicable to both single 2-lane and dual 2-lane cross section options:

- Full semi-transverse ventilation with mechanical smoke extraction; this would typically require a duct with mechanical extract dampers in the ceiling of the central part of the tunnel, linked to extract fans and an exhaust stack at one end. This would be supplemented by jet fans (axial flow fans) mounted in the ceiling of the outer 100m or so of the tunnel adjacent to the portals.
- Longitudinal ventilation using jet fans mounted in the ceiling of the tunnel at regular intervals. If fans were required in the immersed tube section of the tunnel, they would be accommodated in raised niches above the traffic gauge.

The ventilation of the tunnel during normal operation is then achieved using as much of the emergency ventilation system's equipment as practicable. The rationale for this approach is to minimise the amount of emergency-only equipment and so maximise the likelihood of the emergency ventilation system functioning correctly on the rare occasions it will actually be required.

Current thinking therefore tends towards simplifying ventilation as much as possible. Given adequate provision of an escape passage and exits, it will be possible to evacuate tunnel users before hot smoke (which rises and accumulates at roof level) reaches them. The longitudinal ventilation system is then simpler and cheaper, and we have based the cross sections of tunnels in this report on the use of longitudinal ventilation by jet fans.

10.6.3 Other Provisions

Table 10.1 below summarises the fire life safety requirements from both BD78 and RTSR. The main differences are:

- Emergency exit spacing no more than 500 m (RTSR). 100m (BD78);
- Longitudinal gradients not more than 5% (RTSR), not more than 6% (BD78) (refer note at end of Table 10.1)
- Some equipment required by RTSR would be decided upon by the TDSCG;
- An emergency stopping lane would normally be provided (BD78/99) (but very rarely is in practice).

RTSR also indicates that there could be different design fires for the equipment and the structure. As this is an underwater tunnel the structural design fire will need to be severe (for example 200 MW lasting for 4 hours) whereas the equipment design fire would be much less severe (typically 30 MW for 2 hours for the ventilation system).

Two key requirements have potential impact on spatial provision within the tunnel cross section: *escape routes/emergency exits* and *emergency stopping lanes*. There are different requirements according to whether the tunnel is single or dual duct.

Escape Routes/Emergency Exits are at the discretion of the "Administrative Authority" as indicated by a quantitative risk analysis - if the analysis demonstrates that smoke

remains a risk, then some means of emergency exit for pedestrians needs to be provided. In a single 2-lane tunnel, direct means of escape could be provided by vertical escape stairs either side of the river, which would be approximately 600m apart. The rise from road level to ground level is of the order of 15m (12 flights) so there remain safety issues for the elderly and the infirm and for wheelchair users; this would be a further issue to take into account in the risk analysis.

Table 10.1 Fire Life Safety Requirements

Safety Provision	BD78	RTSR	Comments
Number of tubes		✓Where a 15 year forecast shows AADT>10,000/lane, a twin tube tunnel with uni-directional traffic shall be in place at the time when this value will be exceeded. [Art2.1.2]	Forecast traffic already likely to breach this limit. However tunnel is not on TERN.
Escape routes		✓Must lead to open air via direct exit, cross-connection between tubes, emergency gallery or shelter. [Art 2.3.3] Shelters must lead to open air [Art 2.3.4]	Cross connection available for dual 2-lane section, escape gallery for single 2-lane.
Emergency exits	✓100m nominal intervals By TDSCG	✓Where traffic >2,000/lane, must be provided at intervals not less than 500m [Art 2.3.8] Doors required to keep exits smoke-free [Art 2.3.9]	Further detail of many provisions of BD78 is covered in "non-mandatory shall clauses".
Longitudinal gradient	not >6%, less preferred	✓Not greater than 5%. Additional risk assessment .3%	
Emergency Telephones	✓50m nominal intervals	✓ every 50-150m	
Radio Re-broadcasting System (leaky feeder)	By TDSCG	✓ including special channels for emergency services + mobile phones + signed frequencies every 1000m	
Traffic Loops	By TDSCG		
CCTV	By TDSCG	✓ including automatic incident/stopped traffic detection	
Hand Held Fire Extinguishers	✓	✓ every 50-150m and at portals	
Pressurised Fire Hydrants	✓50m nominal intervals	✓ every 50-150m	
Fire Hose Reels	By TDSCG		
Emergency Exit Signs	✓	✓ every 50m, 1-1.5m above escape route level with distances + lighting	
Lane Control and Tunnel Closure Signs/Signals	✓	✓	

Safety Provision	BD78	RTSR	Comments
Emergency Stopping Lane	✓widened verge to accommodate stranded vehicle		
Emergency Walkway	✓min width 1m		
Escape Doors	✓		
Drainage	✓gulleys at 20m c/s	✓ well-designed slot gutter	
Ventilation for Smoke Control	✓	✓ Longitudinal if QRA indicates otherwise dampers and control of flow/smoke velocities	
Power supply		✓ (UPS, double supply, generator)	
Fire resistance of equipment		✓	Further detail of many provisions of BD78 is covered in "non-mandatory shall clauses".
Fire resistance of structure		✓	
Fire detection		✓ manual	
Permanent lighting		✓	
Safety lighting		✓	

"By TDSCG" denotes that provision is within the discretion of the Tunnel Design and Safety Coordination Group"

An alternative to the vertical escape provision would be a parallel escape gallery, with cross connections to the main tunnel at not greater than 500m intervals (according to RTSR, in UK these are commonly provide at 100m intervals as required by BD78). When a fire detection device is triggered, the escape gallery is lightly pressurised (in a similar manner to escape stairs in high rise buildings) to minimise penetration of smoke when access doors are opened. However, the escape gallery must be connected to the open air, the provision of "safe refuges" not so connected where tunnel users can await later rescue, are not now recommended. Again, the use of such escape galleries may not resolve safety issues for the elderly, infirm and wheelchair users (refer 10.6.4 below).

In a dual duct tunnel, the opposite duct may be used as both a place of refuge and a means of escape. Access must be provided by means of cross passage doors which are designed to be fire and smoke proof.

Emergency Stopping Lane - BD78/99 calls for the consideration of emergency stopping lanes within a bi-directional traffic tunnel, although it notes that continuous provision may be expensive and difficult. It is also not clear whether an emergency stopping lane is required for each traffic lane; this would logically be required (refer 10.6.5 below).

10.6.4 Traffic Spatial Requirements

(Note: to avoid confusion between the UK and the continent, PIARC uses the terms “driving lane” and “overtaking lane” to define what in UK are the left hand (near) lane and the right hand (off) lane. For a single duct tunnel of course both lanes are “driving lanes” but in opposite directions. The term “carriageway” indicates the area inside the inner edges of the outermost traffic lane markings. “Off carriageway” denotes the area outside the carriageway including edge lane markings, clearances, emergency lanes, walkways and barriers.)

Single 2-lane tunnel

The basic traffic requirements in accordance with BD78/99 are shown in Figure 10.1. Two 3.65m lanes make up the 7.3m carriageway. The off carriageway width adjacent to the driving lane is 1.7m made up of a 1m verge used as a walkway and an allowance of 0.7m for a hardstrip. BD78 notes that the provision of hardstrips in tunnels is subject to cost benefit analysis and 0.7m is a compromise between the normal minimum of 1m and no provision at all.

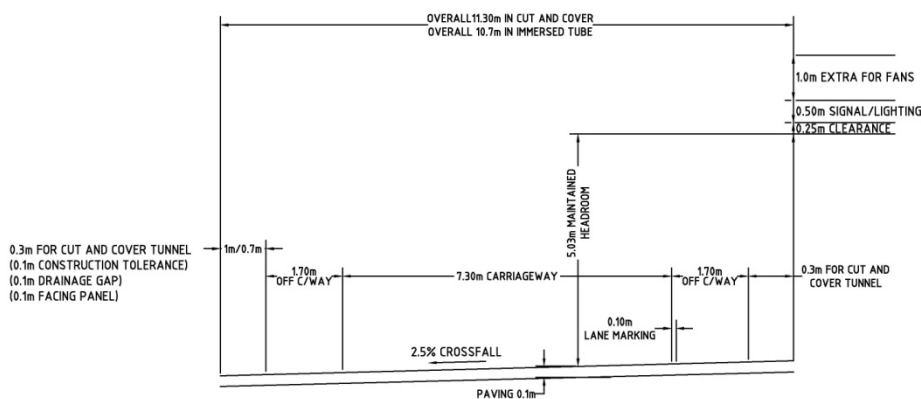

Figure 10.1 Cross Section 2-lane 2-way Tunnel

Maintained headroom is 5.03 m with a clearance of 0.25m to the equipment zone. This would normally be at least 0.4m for signs, lighting etc but will be increased here because of ventilation and smoke extract requirements discussed above. If jet fans or an exhaust duct are required, up to an additional 1.0m clearance may be required; jet fans and signs etc are not co-located so that this provides an effective total of 1.5m to accommodate fans or an exhaust duct.

Fans can be accommodated in the upper segment of a bored tunnel or in additional vertical clearance in cut and cover tunnel. If fans are required in the immersed tube itself (and by careful arrangement of fans this can be avoided), then they are usually accommodated in locally raised niches in the roof (refer to the drawings in Appendix 8)

Since there is no parallel traffic tube for tunnel users to escape into in the case of fire, an escape passage is necessary. This is shown on the immersed tube and cut and cover cross sections (refer to the drawings in Appendix 8); typically it is 1.5m wide with access doors at not more than 100m spacing. The passage must lead to open air at the portals (or be connected to escape stairs but these raise access issues as above). When fire alarms are activated the escape passage is lightly pressurised to prevent the spread of smoke into the passage. In a bored tunnel it is more difficult to provide this escape passage but it may be achieved by introducing a vertical wall to separate a small section of the carriageway (with a penalty to traffic space).

Dual 2-lane Tunnel

The traffic requirements are similar to the single 2-lane tunnel. However, since traffic is not normally bi-directional within either duct, the hardstrip has been reduced to 0.3m on each side (final hardstrip provision will need to be discussed and agreed with the highway authority at a later stage).

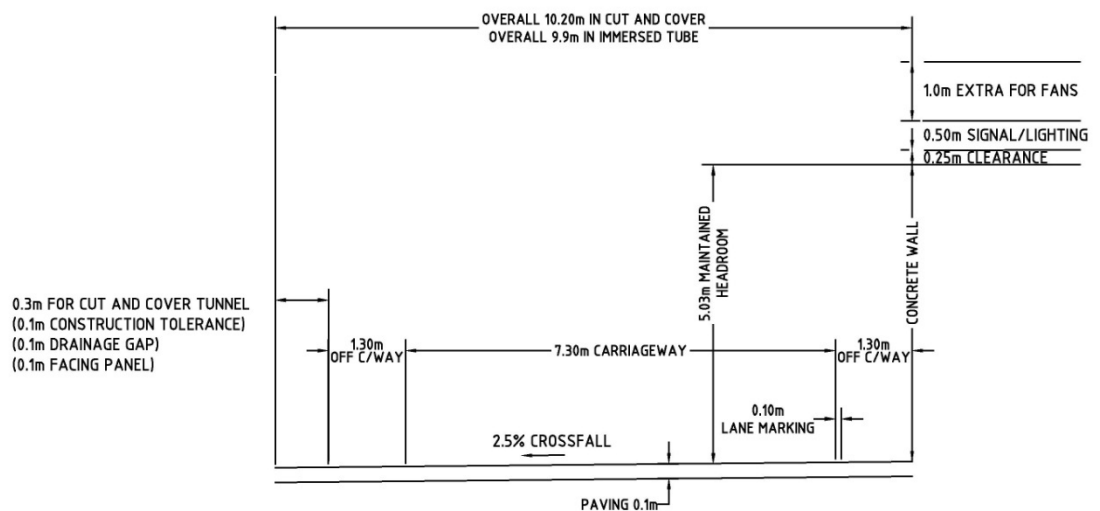

Figure 10.2 Cross Section Dual 2-lane Tunnel

The opposite traffic duct can also serve as an escape passage so that the separate escape passage is no longer required.

10.6.5 Emergency Stopping Lane

Since a single 2-lane tunnel is intended to run normally as a bi-directional tunnel, consideration will need to be given to the provision of an emergency stopping lane. The consequences of tunnel blocking by breakdown or accident are serious and there is a clear need for an emergency stopping/access lane within the tunnel cross section. This lane could simply be another 3.65m lane. Dutch practice is to provide only sufficient space for a vehicle to pull off the carriageway i.e. an enhanced off carriageway zone. For HGVs, this width is assessed at 3.2m, showing a saving of 0.45m lane width + the normal hardstrip of 1.0m, total 1.45m.

However logic suggests that that the provision of even a single emergency stopping lane (and as discussed above, such a lane would sensibly be required for each traffic lane) is beginning to get close to providing a full dual 2-lane facility when many of the other safety issues such as pedestrian escape begin to fall away (because there is an adjacent bore for fire access and escape). This would also enable the RTSR requirement for a twin duct tunnel where 15 year forecast AADT exceeded 10,000 vehicles / lane to be met.

Emergency lay-bys are an alternative; a pair of these at the centre of the tunnel would meet the RTSR 700m maximum spacing requirement. They could be formed within local enlargements of the bored tunnel cross section. For the immersed tube, it would be more convenient to place them in the cut and cover sections, adjacent to the interface with the immersed tube - one extra lay-by would need to be provided in each direction. This avoids local changes to the otherwise constant immersed tube section which lends itself well to precast production techniques.

For the dual 2-lane tunnel, the second lane can be used as the emergency stopping lane.

10.7 Pedestrian Usage

Dedicated pedestrian usage of a highway tunnel is unusual in UK although there are some examples in Europe e.g. Maas Tunnel in Holland which contains a wide, well-lit and attractive pedestrian gallery. As discussed earlier, a pedestrian gallery would have to be self contained and separate from any escape gallery for use by tunnel users in emergency.

It remains to be seen how attractive such an option would be to pedestrians. Unless the gallery is well-lit and maintained, it is unlikely that pedestrians would use it. To minimise its length and make access straightforward from shoreside promenades, vertical access by means of lifts would have to be provided, otherwise pedestrians would have to double back to enter via the traffic portals, probably not an attractive option.

A pedestrian gallery could be added fairly easily to either of the immersed tube and cut and cover cross sections (at a cost). It would be more difficult to add to the bored tunnel cross section and a separate pedestrian tunnel would probably be required - almost certainly not cost-effective.

10.8 Conclusions

Tunnel alignments have been investigated on three corridor options, Protected Corridor (Northern Alignment), South of the Protected Corridor (Southern Alignment) and at the Thames Barrier. In addition previous studies of a third bore to the Blackwall Tunnel have been reviewed.

We concur with the conclusions of the 1997 Report that there is no cost-effective option for a third bore at the existing Blackwall Tunnel.

The Northern Corridor Alignment can accommodate an immersed tunnel alignment but only if the entry / exit gradient on the Silvertown side is increased to 6%. This route remains attractive however as there are few existing constraints.

An immersed tube tunnel can be constructed on the Southern Corridor Alignment using either the desirable gradient of 4% or the maximum desirable gradient of 5%. A bored tunnel at gradients of 5% could also be accommodated. These gradients would increase traffic capacity and reduce ventilation requirements but there are land acquisition problems (clearance of two riverside plots currently used for industrial purposes) to be resolved on the Silvertown side.

An immersed tube tunnel is also feasible east of the Thames Barrier at entry/exit gradients of 4% or 5%. A bored tunnel has not been tested on this route

A bi-directional 2-lane tunnel creates operational and safety difficulties and is not in accordance with RTSR 2007. Mitigating measures, such as provision of breakdown lanes, are possible but enlarge the tunnel to the point where a dual 2-lane cross section could be a more viable alternative. A dual 2-lane immersed tunnel cross section has been investigated and offers resolution of many of the disadvantages of the single 2-lane section at a reasonable marginal cost. A dual 2-lane bored tunnel would require twin, identical, bores with no guarantee, depending on ground conditions, that cross passage connections could be achieved. The marginal cost of such twin bores is likely to be greater than the marginal cost of the dual 2-lane immersed tube but is very dependent on re-use of the tunnel boring machine used for construction

References

- 1 BD78/99 Design of Road Tunnels, Design Manual for Roads and Bridges, Highways Agency.
- 2 Directive 2004/54/EC of the European Parliament and of the Council on Minimum Safety Requirements for Tunnels in the Trans-European Road Network, OJEU 2004.
- 3 Road Tunnel Safety Regulations 2007, 2007 No 1520, Highways, Tunnels, Statutory Instrument.
- 4 TD27 Cross Sections and Headroom, Design Manual for Roads and Bridges, Highways Agency
- 5 Mott MacDonald Ltd, Blackwall Third Crossing, Technical appraisal Report, Volume I Report, Doc Ref 36912\HWY\WIN\002\Rev E, Government Office for London, November 1997.

- 6 Mott MacDonald Ltd, Blackwall Third Crossing, Third Tunnel option, Technical paper on Engineering and Operational Feasibility, Doc Ref 36912\HWYWIN\005\Rev B, Government Office for London, September 1997.

11 Footbridge Options

11.1 Original Footbridge Form.

The study initially considered a low level opening bridge as envisaged in the original brief.

The form of bridge, which is shown on Drawing No S004-LN01198-NED in Appendix 7, comprised a low level viaduct with a central lifting span, providing a clear navigation width of 200 m, and an air draught of 15 m above Mean High Water Spring Tides (MHWST) when lowered, and 50 m above MHWST when raised.

The general form of main span, lifting system and control systems is similar to that proposed for the Low Level Lifting Road Bridge. The length of the approaches was kept to the minimum possible by eliminating the need for long lengths of ramps at 1 in 20 gradient. Instead lifts and stairs were provided, as close to the river banks as possible.

The study noted that the number of occasions that the bridge would have to open for shipping would be significant and that the Port of London Authority may object to a bridge at that level.

Discussion with TfL regarding the form and location of the bridge resulted in the study being modified.

11.2 Bridge location

Options for the location of a link to provide pedestrian access from the West India Docks / Crossharbour area to the O₂ Arena / North Greenwich station area were studied. Four options were examined in terms of available space, navigation and convenience of use for the public. Locations are considered on the basis of a site visit and examination of aerial photographs. Issues of land ownership, planning constraints, rights of way etc. have not been considered at this stage.

A plan showing each of the locations is shown below:

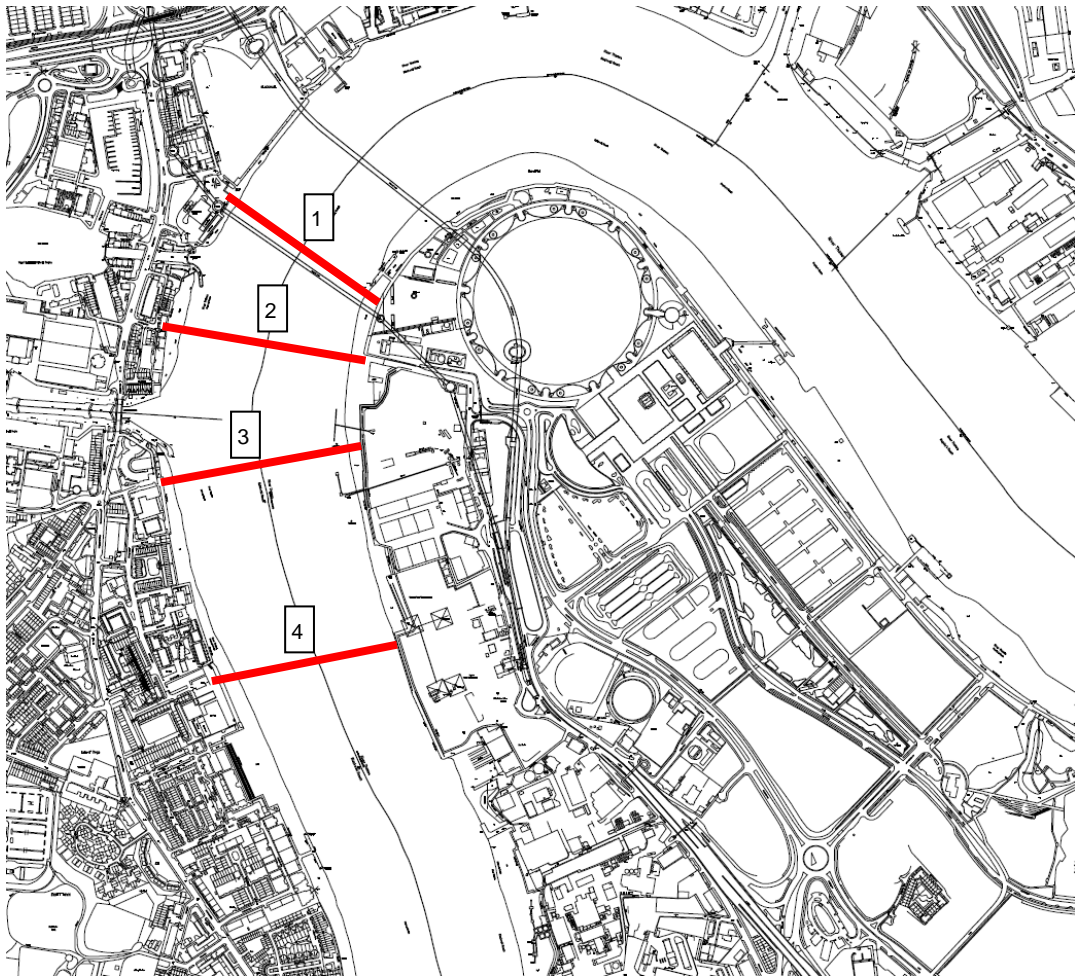

Plan showing proposed footbridge alignments

Following discussion with TfL, alignment options 3 and 4 were discounted as they do not match the anticipated pedestrian origins and destinations very well. Alignment options 1 and 2 are very close to the bend in the river, and therefore the proposed span of the bridge was increased to 300m to mitigate the potential for vessel impacts and other navigation issues associated with the location.

11.2.1 Option 1 Yabsley Street to the O2 arena

This is the most northerly option and provides a direct link into the O2 arena on the south bank. On the North bank Yabsley Street is close to Blackwall DLR station and also convenient for Canary Wharf stations and other West India Docks transport links.

The proposed landing site on the north bank is situated between a new residential development to the north and the Northumberland Wharf recycling centre to the south. It comprises a landscaped area and disused slipway, see photographs below. This site has the advantage of being fairly open with minimal land take and has straightforward pedestrian routes to Canary Wharf and Blackwall DLR station. A high level bridge may however present privacy issues with the adjacent residential development. There is also a working wharf adjacent that accepts deliveries by barge very frequently which may require the bridge abutments to be located landward of the river wall for navigation safety reasons, increasing the land take required.

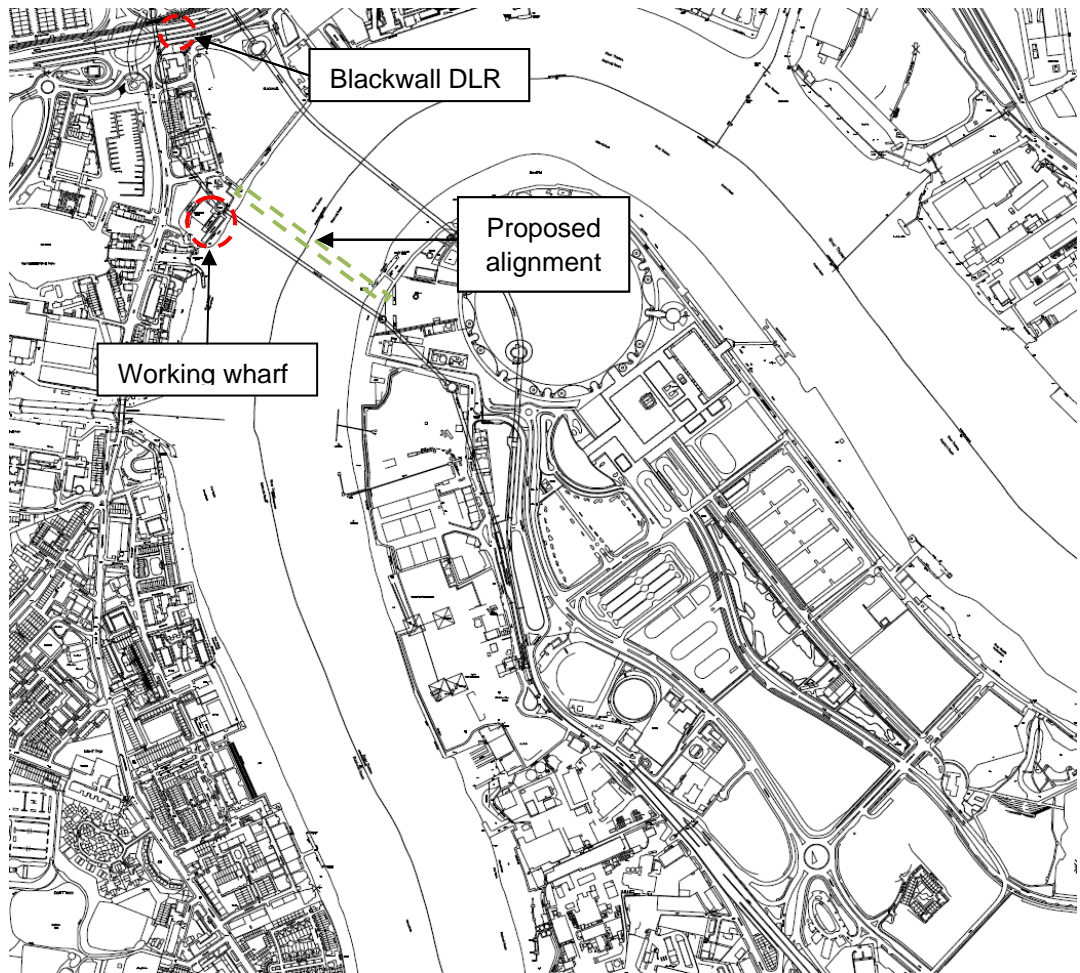

Option 1 location plan



View from Yabsley Street showing landscaped area, north bank



Disused slipway adjacent to landscaped area, north bank



Northumberland Wharf recycling centre (working wharf) on north bank

The proposed landing site on the south bank would be situated adjacent to an existing jetty (currently being used as a nature habitat). The bridge abutment would be located within the river with a link provided onto the Thames Path. The advantage of this location is that it provides good access into the O₂ and although the abutment would be located in the river, the presence of the existing jetty will mean that there is little detrimental effect to the navigation of vessels.



View on south bank showing existing jetty



Option 1 Aerial Plan



View on north bank

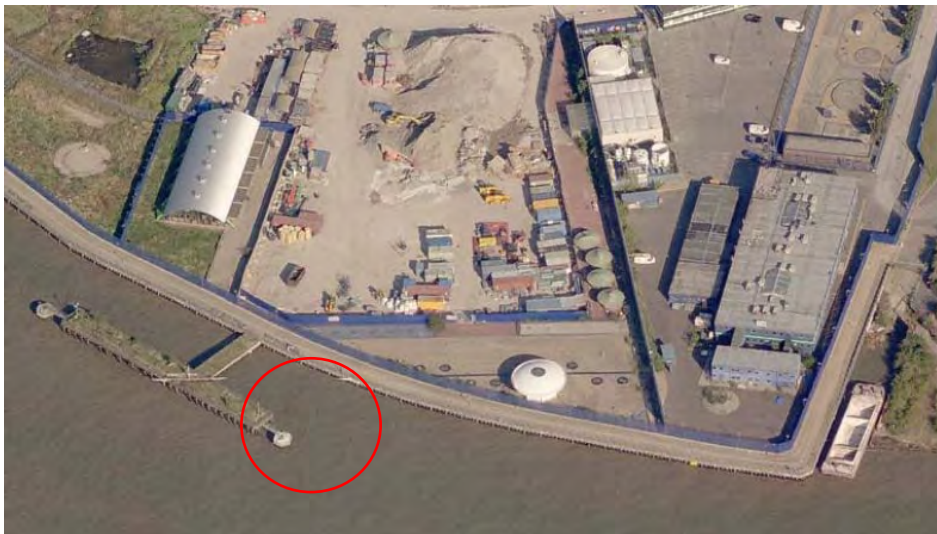

View on south bank

11.2.2 Option 2 Cold Harbour to Draw Dock Road

This option provides a link to the west of the O₂ arena on the south bank and into Cold Harbour road on the north bank. Cold Harbour is a short walk to Canary Wharf stations and other West India Docks transport links including Blackwall DLR. On the south bank Draw Dock Road would provide good access to the main gates of the O₂ Arena and also North Greenwich station.

The north bank is heavily developed at this location and there is no existing link through from the Thames to Cold Harbour road. The logical option in this case would be to acquire a building and demolish it to allow a clear route though. There are straightforward pedestrian routes to Canary Wharf and Blackwall DLR station but a high level bridge may present privacy issues with the adjacent residential developments. The bridge abutment could be located within the river at this location with little detrimental effect to the navigation of vessels. This would minimise land take on the shore.

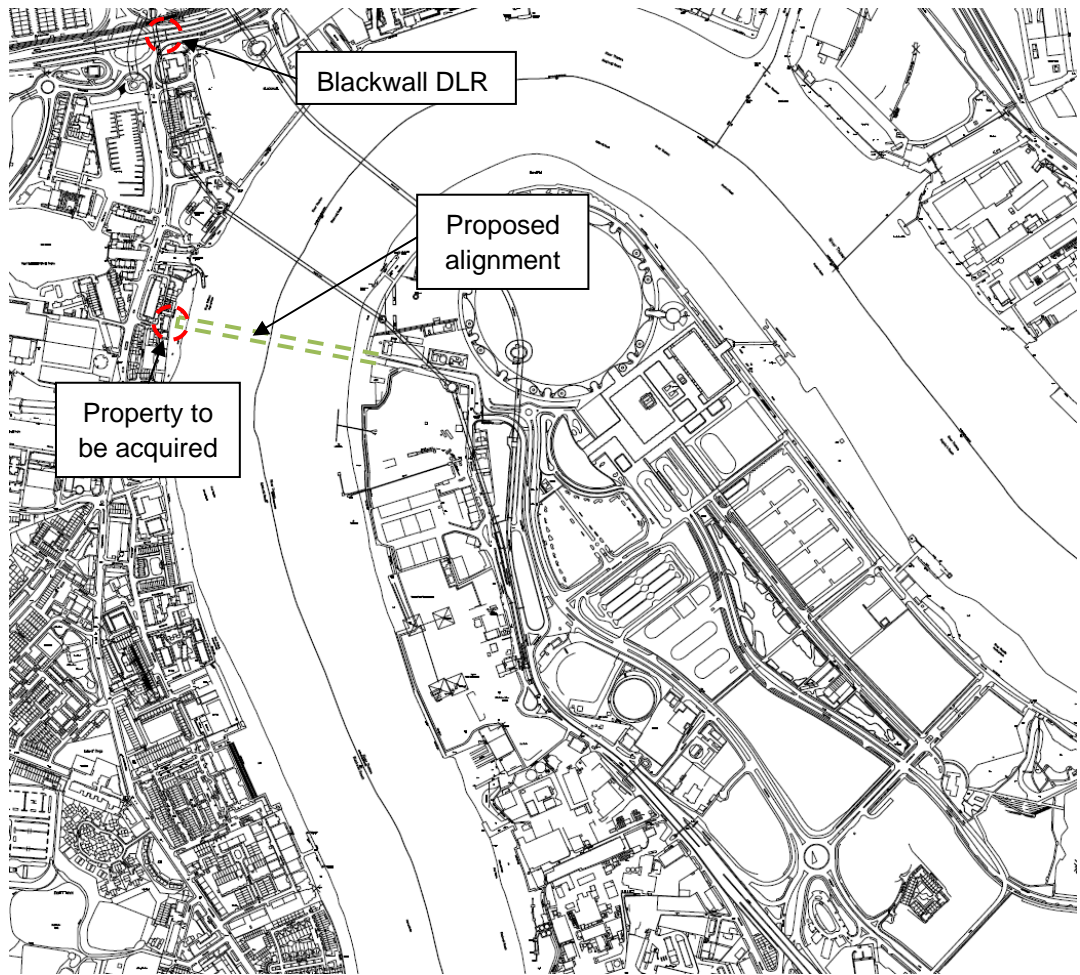

Option 2 location plan



View on Coldharbour road (showing potential building to be acquired for demolition)



View of north bank (showing potential building to be acquired for demolition)

On the south bank the bridge abutments could be located within the area of the existing slipway (status unknown). This would make the link into Draw Dock Road and onward to the Arena relatively straightforward. Again there would be little detrimental effect to navigation at this location.



View (looking east) of the Thames path and adjacent slipway



Option 2 Aerial Plan



View on north bank



View on south bank

11.3 Bridge Type and Form

A variety of bridge types have been considered for this location, including a fixed high level bridge, an opening bridge, a cable car and a transporter bridge.

The 300m length of clear span effectively rules out most forms of opening bridge, the most practicable being a lifting bridge, similar but longer than that shown on Drawing No S004-LN01198-NED in Appendix 7. The bridge will need to be set at quite a high level (upwards of 25m) when in its lowered position to keep the number of times that the bridge has to open to a workable level. At this height it will be necessary to provide lifts or escalators for the pedestrians to reach the bridge deck, and any advantages that a lifting bridge may have over a fixed bridge are lost.

A cable car would need to be set at a height of at least 50m to the underside of the cars to give navigation clearance. Therefore the cable run needs to extend some distance from the river banks to achieve the necessary height, and this would be impractical without significant land acquisition.

The study therefore concentrated on a fixed high level bridge and on a transporter bridge. The transporter bridge is, in effect, a fixed high level bridge but with a moveable suspended platform at low level. The structural form has initially been chosen to have some similarities with the masts of the O₂ arena. Other structural forms and architectural themes can easily be developed.

11.4 Pedestrian options

Consideration of whether to opt for a transporter bridge or a fixed high level bridge, and means of transporting people to the high level should take crossing time and capacity into account as well as cost. Each of the options is briefly reviewed below.

Transporter Carriage.

This is the cheapest of the options considered and perhaps the most unusual. It has the advantage that crossing is at embankment level.

The primary means of crossing the river is effected by walking onto the transporter carriage which then travels across the river. The loading, unloading and crossing times could be likened to a ferry operation, but with everything being quicker and not affected by tides. The wide entry gates and stable platform facilitate rapid loading and unloading. Speed of crossing could be quite high (of the order of one minute, plus set off and docking). Therefore a total crossing time of 4 to 5 minutes could possibly be achieved, giving a notional service frequency of 10 minutes in each direction, which is comparable to that achieved by the Woolwich ferry using two ferries. Waiting plus crossing time is therefore between 5 and 15 minutes. If the carriage is sized to take 250 people at a time that would give a throughput of $6 \times 250 = 1,500$ people / hour in each direction. This could be increasing by making the carriage larger.

A staircase and service lift is incorporated into each end of the bridge and a simple walkway at the high level allows access for maintenance. The staircase and walkway could be made available for public use.

Drawing S006-LN01198 in Appendix 7 illustrates the option.

High level bridge with high speed lifts.

This option has a cost of the order of £2m above that of the transporter bridge. This figure includes an allowance for two large high speed lifts at each end of the bridge, with a glazed and covered lift lobbies and a glazed enclosure to the high level walkway. Total crossing time would be made up of waiting for a lift at the start, going up in a lift, walking across the bridge, waiting for a lift and going down. This gives a total crossing time of between 8 and 12 minutes. If each lift has a capacity of 50 people and a cycle time of 4 minutes, then the throughput for two lifts is $15 \times 2 \times 50 = 1,500$ people / hour in each direction.

High level bridge with escalators.

This option has a cost of the order of £17m above that of the transporter bridge. This figure includes an allowance for three escalators at each end of the bridge, (one up, one down, one reversible / under maintenance) with a glazed and covered lobbies and a glazed enclosure to the escalators and high level walkway. In addition a small lift is included at each end of the bridge to allow mobility impaired access. We assume each escalator has a rise of 25m, which is considered the practical maximum, and therefore there is one intermediate landing at each end of the bridge. If the escalators are provided to LUL standards then there is a premium of approximately £6m. Total crossing time will be made up of going up two escalators, walking across the bridge, and going down two escalators. This gives a total crossing time of between 9 and 12 minutes. Throughput is of the order of 6,000 people / hour per escalator, so if operating two escalators in the peak flow direction then throughput could approach 12,000 people per hour.

High level bridge with moving walkways.

This option has a cost of the order of £21m above that of the transporter bridge. This figure includes an allowance for three moving walkways at each end of the bridge, (one up, one down, one reversible / under maintenance) with a glazing to the whole of the end towers of the bridge and a glazed enclosure to the high level walkway. In addition a small lift is included at each end of the bridge to allow mobility impaired access. We assume each walkway has a rise of 10m, which is based on the maximum gradient of 12 degrees, and therefore there are four intermediate landings at each end of the bridge. (Note that the figure does not include for horizontal moving walkways at the high level.)

Total crossing time will be made up of going up five inclined moving walkways, walking across the bridge, and going down five inclined moving walkways. This gives a total crossing time of between 16 and 25 minutes, the shorter time assuming that one walks rather than stands on the moving walkway. Throughput is similar to that of the escalator system.

12 Cost Estimates

The capital cost of implementing the options are set out in the tables in Appendix 9 and represent three different options:-

- A new Tunnel with approach roads,
- A new Road Bridge with approach roads ,
- A new Foot / Cycle Bridge,

For each of these alternatives a number of different options have been considered. The cost represents the indicative capital cost for each option to a base date of April 2009 [2Q/2009] price level.

Economic Review

Tender prices over the last year have reduced reflecting the current Banking Crisis and economic down turn. Inflation is being contained by cost cutting and lower profit margins. However should the market pick up or inflation not be controlled there will be a rapid increase in costs. This will affect costs reflective of the bottom of the market the most.

Cost Commentary

The indicative capital cost for each scheme excludes the following items

- a** Scheme Promoters Costs – In-house promoters and project manager for the duration of the period for obtaining approvals
- b** Planning and Design Costs – The cost of preparation of the outline design to a stage that allows a contract to be let.
- c** Documentation and Legal Costs – Planning and financial issues.
- d** Liaison Costs and Liaison with Local Authorities – In setting up the planning and design parameters it will be necessary to consult and liaise with different bodies and the cost of the time involved in this exercise.
- e** Technical Survey Costs –The development of a number of surveys, traffic, site investigation etc are likely to be required in advance of the schemes procurement to reduce risk.
- f** Land, Property and Compensation Costs – At this stage the ownership and extent of the land beyond the foot print of the scheme is not established and is not included in the costs.
- g** Supervisory Services – Regardless of the method of procurement the construction works will require a certain amount of design approval and supervision.
- h** Project Management Costs – Whether in-house or externally provided there will be project management costs to take over from the Scheme for the daily responsibility for procuring the project once approval has been obtained.
- i** Other Consultant Costs – No allowance has been made for the use of specialist consultants who are not normally part of the design team.

- j Contingency Costs – No allowance has been included for contingencies, normally at this stage of design an allowance of 30% should be made.
- k Risk Costs – The costs of Risk to the Scheme has not been evaluated as it is dependant on the parameter of the scheme being determined. [See following section on Design Risks].
- l Value Added Tax – VAT is not included in the Indicative Costs, currently at 15% but shortly to be re-instated at 17.5%.
- m Programme Costs – The cost of the scheme will be determined by the programme for the works and whether a “realistic”, “optimistic” or “pessimistic” programme is adopted.

13 Risks

The main risk to the scheme is the protection of the possible locations identified. This not only applies to the schemes footprint but also vertical alignment, connections to the existing infrastructure and adjacent developments. If the routes identified are not protected the schemes become impractical.

The risk of each elemental cost is set out in the table in Appendix 9.

14 Discussion and Recommendations for further studies

The provision of a Thames crossing in the Blackwall / Silvertown area has been the subject of preliminary study and discussion for many years. One of the earlier schemes resulted in a safeguarded alignment, based on either a lifting road bridge or a tunnel. The safeguarded route has been incorporated in the Unitary Development Plans for the London Boroughs of Newham and Greenwich, but the two plans do not actually match. It is therefore not possible to construct a crossing that lies entirely within the safeguarded area on both sides of the river.

Since the study, which resulted in the safeguarded route, was carried out there have been a number of physical changes to the area. The most significant physical changes are the construction of the Millennium Dome (now the O₂ arena) and ongoing redevelopment of the Greenwich peninsula, together with the construction of the Docklands Light Rail (DLR) extension to London City airport. These developments have an impact on the crossing.

The development of the Greenwich peninsula increases the desirability of providing pedestrian and cycle access in addition to a highway crossing, and also increases the need to ensure that any structures are visually pleasing. The elevated DLR structure presents a physical constraint on any highway alignment on the north side of the river.

In addition to the physical changes, there have been alterations in accepted standards for highway and tunnel construction. These changes are primarily related to user safety and concern the fire and life safety provisions for tunnels and the acceptable horizontal

and vertical alignments for all highway schemes. The gradients and horizontal alignments used in the previous studies are not considered workable using currently accepted good practice.

Horizontal alignments are constrained by the existing infrastructure, land use and suitable places for connection to the highway network. Vertical alignments for bridge options are severely constrained by the DLR extension, by navigation requirements and aviation requirements. The visual intrusion of a high level structure is also significant. Vertical alignments for tunnel options are also severely constrained by the existing infrastructure, DLR extension, land use and suitable places for connection to the highway network.

A number of alignments that satisfy the various constraints have been considered and are presented in this report. A brief commentary on the schemes is presented as a starting point for further discussion.

Low Level Opening Highway Bridges.

A low level bridge (15m air draft when open to road traffic) has been considered. A low level bridge potentially offers an attractive option for pedestrian and cyclist use and is likely to be the easiest to accommodate from visual considerations. The navigation studies indicate that the bridge would have to be raised for at least 15 vessels per day. It is possible that some of the vessels would pass through at the same time. The number of openings (typically of 30 minutes duration) is significant and there would be considerable disruption to highway traffic. It is possible that the Port of London Authority would object to a bridge at this level. It is unlikely that a highway bridge at this level will be acceptable to all stakeholders.

Medium Level Opening Highway Bridges (1).

The horizontal alignment considered for the 15m high opening bridge can also be utilised for a bridge providing around 25 to 26m air draft for navigation. This can be increased to 30 or 31m by changing the location of the tie-in to the highway network on the Greenwich peninsula. The number of openings is likely to be around five times a day, and the consequent disruption is significantly less than for the low level bridge. This option has some potential, but further work is needed to establish the likely acceptability to stakeholders and the implications of land ownership and usage on the proposed alignments. The study has considered a single carriageway and dual carriageway crossing. Both are technically viable. Traffic studies and future projections are needed to confirm which is relevant.

Medium Level Opening Bridges (2).

An alternative alignment that can accommodate an opening bridge providing 35m or 37m air draft for navigation has been considered. At this level the bridge would not have to open very often. The presence of the DLR presents a significant constraint in providing a horizontal alignment with sufficient length to provide an acceptable gradient for the 35m clearance. The proposed alignment therefore passes above the DLR extension and has a significant length of highway on elevated viaduct. From a functional point of view, this option appears feasible. However, the visual aspect of such a structure and costs entailed with such a long viaduct cast doubt on its viability.

High Level Fixed Bridge.

The same alignment can be used for a 50m high level fixed bridge as for the 35m opening bridge. A high level fixed bridge is likely to be more acceptable to PLA than an opening bridge. Maintenance and operating costs will also be lower than for an opening bridge. As with the 35m opening bridge, the visual aspect of such a structure and costs entailed with such a long viaduct cast doubt on its viability.

Tunnels.

Alignments have been investigated on three corridor options, Protected Corridor (Northern Alignment), South of the Protected Corridor (Southern Alignment) and at the Thames Barrier. In addition previous studies of a third bore to the Blackwall Tunnel have been reviewed.

We concur with the conclusions of the 1997 Report that there is no cost-effective option for a third bore at the existing Blackwall Tunnel.

The Northern Corridor Alignment can accommodate an immersed tunnel alignment but only if the entry / exit gradient on the Silvertown side is increased to 6%. This route remains attractive however as there are few existing constraints.

An immersed tube tunnel can be constructed on the Southern Corridor Alignment using either the desirable gradient of 4% or the maximum desirable gradient of 5%. A bored tunnel at gradients of 5% could also be accommodated. These gradients would increase traffic capacity and reduce ventilation requirements but there are land acquisition problems (clearance of two riverside plots currently used for industrial purposes) to be resolved on the Silvertown side.

An immersed tube tunnel is also feasible east of the Thames Barrier at entry / exit gradients of 4% or 5%. A bored tunnel has not been tested on this route

A bi-directional 2-lane tunnel creates operational and safety difficulties and is not in accordance with RTSR 2007. Mitigating measures, such as provision of breakdown lanes, are possible but enlarge the tunnel to the point where a dual 2-lane cross section could be a more viable alternative. A dual 2-lane immersed tunnel cross section has been investigated and offers resolution of many of the disadvantages of the single 2-lane section at a reasonable marginal cost. A dual 2-lane bored tunnel would require twin, identical, bores with no guarantee, depending on ground conditions, that cross passage connections could be achieved. The marginal cost of such twin bores is likely to be greater than the marginal cost of the dual 2-lane immersed tube but is very dependent on re-use of the tunnel boring machine used for construction

A tunnel solution, once constructed, provides no disruption to navigation and is not affected by aviation considerations. It is therefore likely to be the option most favourably viewed by many stakeholders. Whilst provision can be made for pedestrian and cyclists within a dedicated cell of the tunnel, experience shows that most pedestrians do not like tunnels. Further work is needed to establish the likely acceptability to stakeholders and the implications of land ownership and usage on the proposed alignments.

Opening Footbridge.

A number of potential alignments for a pedestrian and cycle bridge have been considered. The study initially considered an opening bridge providing a 15m air draft when in the lowered position. The number of openings (typically of 30 minutes duration) is significant and there would be considerable disruption to

pedestrian traffic. It is possible that the Port of London Authority would object to a bridge at this level and it is unlikely that a bridge at this level will be acceptable to all stakeholders.

Fixed and Transporter footbridges

Two potential alignments have been identified for a fixed high level footbridge or for a transporter bridge. The transporter bridge option offers an economic and potentially iconic solution to the provision of a crossing for pedestrians and cyclists. If suitable bollards are introduced on the approach walkways it would also be possible for vehicles such as police or ambulance to use in an emergency.

A high level fixed bridge offers the possibility of greater pedestrian capacity if fitted with escalators at each end, albeit at greater construction cost.

The options are feasible, but further work is needed to establish the likely acceptability to stakeholders and the implications of land ownership and usage on the proposed alignments.

Appendix 1

Commissioning Brief

COMMISSIONING BRIEF FOR: New Thames River Crossings

Scope of work: Initial Engineering Feasibility Review

Issued by: Richard De Cani, Head of Major Projects

Version: 1.2

Modified by Hyder 26 February 2009

Introduction

Transport for London is seeking support from an Engineering Framework consultancy for initial advice on engineering feasibility of options for a new river crossing in East London.

What information will be provided by TfL

TfL will provide the successful bidder with high-level information on the crossings which will be considered at this stage.

The concepts to be considered are:

- A third bore for the Blackwall Tunnel, incorporating two traffic lanes linking with the existing Blackwall Tunnel approach roads.
- A high-level two-lane single carriageway road bridge between North Greenwich and Silvertown, following the safeguarded Silvertown Link alignment. This will have clearance of approximately 50 m from mean high water level to the underside of the structure, and a central span of 200 m. Approach roads will link to the Blackwall Tunnel approach and the Lower Lea Roundabout in Silvertown.
- A mid-level two-lane single carriageway road bridge between North Greenwich and Silvertown, following the safeguarded Silvertown Link alignment. This will have clearance of approximately 35 m from mean high water level to the underside of the structure, and a central span of 200 m. The central span will be capable of being lifted to provide maximum clearance of 50 m. Approach roads will link to the Blackwall Tunnel approach and the Lower Lea Roundabout in Silvertown.
- A low-level two-lane single carriageway road bridge between North Greenwich and Silvertown, following the safeguarded Silvertown Link alignment. This will have clearance of approximately 12-15 m from mean high water level to the underside of the structure, and a central span of 200 m. The central span will be capable of being lifted to provide maximum clearance of 50 m. Approach roads will link to the Blackwall Tunnel approach and the Lower Lea Roundabout in Silvertown.
- A low-level foot/cycle bridge between North Greenwich and the north bank. Feasibility of north bank landing sites to be advised. The bridge will require a central span of 200 m. The central span will be capable of being lifted to provide maximum clearance of 50 m. Pedestrian access to the bridge will be by both stairs and lift.
- A road tunnel between North Greenwich and Silvertown, following the safeguarded Silvertown Link alignment. A two-way single carriageway preferred but advice on means of meeting safety requirements on evacuation to be advised. Options of bored or immersed tube to be considered.

All bridge options will include provision for use by pedestrians and cyclists, segregated from motor traffic. With tunnel options, the consultant is to advise TfL on the practicability of incorporating day-to-day pedestrian access to any escape route any alongside the road tunnel.

Work previously undertaken will be provided, which includes assessment of high- and mid-level road bridges plus tunnel options at the Silvertown Link. Only limited work has previously been undertaken, and where work has previously been undertaken, the constraints and assumptions may have changed, for example due to changing safety requirements for escape from road tunnels. Therefore the advice sought will be from first principles.

What will be required

Consultants will be required to provide TfL with a technical note setting out:

- Key constraints identified, including requirements for escape from road tunnel options;
- Drawings showing indicative alignment for each of the options, with indicative long- and cross-sections as appropriate;
- Indicative capital cost for each option;
- Indicative timescale for construction following award of powers.
- **Risks: with each elemental cost identified, TfL will wish to see a commentary identifying risks or potential risks that the tenderer has perceived within the project. (note; this bullet point was in the ITT so I have added it here for completeness)**

Programme

Brief progress meetings will be held every 2 weeks.

An interim technical note will be provided to TfL by **9 March 2009, (See methodology)** with a final report by **7 April 2009. (Dates adjusted to reflect appointment date)**

Appendix 2

Background Documents

Thames River Crossings Study

Source Documents

Number	Name	Modified	File Size	Date	Author
1	A102 Blackwall Third Crossing River Bridge - Report on Archeology May 1993.pdf	02/03/2009 09:57	2707038	May-93	Travers Morgan
2	Balckwall Tunnel_Third Bore Crossing_Appraisal of the Hydraulic Implications.pdf	02/03/2009 12:16	13864279	Jul-90	HR Wallingford
3	Blackwall Lifting Bridge - Impact On Road Traffic June 1997.pdf	02/03/2009 09:57	1649203	Jun-97	Halcrow
4	Blackwall Scheme Concept Review.pdf	02/03/2009 09:58	93253280	May-96	Mott MacDonald
5	Blackwall Third Crossing Ground Investigation Part 1.pdf	02/03/2009 09:58	75178208	Oct-93	Travers Morgan
6	Blackwall Third Crossing Ground Investigation Part 2.pdf	02/03/2009 09:59	79756159	Oct-93	Travers Morgan
7	Blackwall Third Crossing_Technical Appraisal Report_Vol I.pdf	02/03/2009 12:16	83974464	Nov-97	Mott MacDonald
8	Blackwall Third Crossing_Technical Appraisal Report_Vol II_Figures Drawings.pdf	02/03/2009 12:24	117327536	Nov-97	Mott MacDonald
9	Blackwall Third Tunnel Report on Contamination Drawings 2.pdf	02/03/2009 09:59	1496345	May-93	Travers Morgan
10	Blackwall Third Tunnel Report on Contamination Drawings.pdf	02/03/2009 09:59	15872958	May-93	Travers Morgan
11	Blackwall Third Tunnel Report on contamination.pdf	02/03/2009 09:59	21412790	May-93	Travers Morgan
12	Blackwall Third Tunnel Technical Paper on Engineering and Operational Feasibility Drawings.pdf	02/03/2009 09:59	9060907	Sep-97	Mott MacDonald
13	Blackwall Third Tunnel Technical Paper on Engineering and Operational Feasibility.pdf	02/03/2009 09:59	5798694	Sep-97	Mott MacDonald
14	Blackwall Tunnel Third Bore Archaeological Assessment Aug 1991.pdf	02/03/2009 09:59	2485071	Aug-91	Oxford Archaeological Unit
15	Blackwall Tunnel Third Bore Study_Report_August 90.pdf	02/03/2009 12:24	97618197	Aug-90	Travers Morgan
16	Blackwall Tunnel Third Bore_Feasibility study for approach structures.pdf	02/03/2009 12:26	62284279	Jul-92	Travers Morgan
17	Blackwall Tunnel Third Bore_Feasibility Study_bridge Option_Preliminary Report_Vol 2.pdf	03/04/2009 09:08	87575316	Jul-92	Travers Morgan
18	Blackwall Tunnel Third Bore_Feasibility Study_Bridge Option_Preliminary Report_Vol 1.pdf	03/04/2009 09:07	70470213	Jul-92	Travers Morgan
19	East Thames River Crossings - Sifting Report - Draft Report.pdf	02/03/2009 09:59	77679242	Mar-98	Government Office for London
20	English Partnerships - Thames Gateway River Crossings - Appendix - Final Report.pdf	02/03/2009 09:59	10084323	Apr-00	Roger Trym & Partners
21	English Partnerships - Thames Gateway River Crossings - Final Report.pdf	02/03/2009 09:59	54025543	Apr-00	Roger Trym & Partners
22	English Partnerships - Thames Gateway River Crossings Strategic Integration Study - Interim Report.pdf	02/03/2009 09:59	85421359	Apr-00	Halcrow
23	Navigation Constraints Design options study D3.pdf	02/03/2009 10:00	748774	Nov-02	Hyder
24	New Thames Crossing - Background Briefing.pdf	02/03/2009 12:52	4097815	Feb-09	TfL
25	Proposed Thames Crossing Study of Vessel Movements.pdf	02/03/2009 10:00	20632263	Jun-97	CWA
26	Sustrans Thames Pedestrian and Cycle Bridge - Feasibility Study_1.pdf	02/03/2009 12:33	3955149	Mar-08	Sustrans/Ramboll/Whitbybird
27	Sustrans Thames Pedestrian and Cycle Bridge - Feasibility Study_2.pdf	02/03/2009 12:33	5258763	Mar-08	Sustrans/Ramboll/Whitbybird
28	TfL_Thames Gateway Bridge_Review of Alternative Alignments.pdf	02/03/2009 12:38	51672025	May-03	Halcrow
29	Thames Gateway River Crossings TfL Position Paper.pdf	02/03/2009 12:39	30744112	Dec-01	?TfL?
30	Thames Gateway River Crossings.pdf	02/03/2009 10:00	31388186	Oct-00	WS Atkins
31	Thames River Crossing - Review reportV6.pdf	02/03/2009 12:33	12021877	Dec-02	Hyder
32	Third Blackwall Crossing Lifting Bridge Tech Paper 1 Navigation.pdf	02/03/2009 10:00	15211964	Aug-97	Mott MacDonald
33	Third Blackwall Crossing Lifting Bridge Tech Paper 2 Navigation.pdf	02/03/2009 10:00	3863726	Aug-97	Mott MacDonald

Appendix 3

London City Airport Safeguarded Surfaces

SAFEGUARDED AND OBSTACLE LIMITATION SURFACES – LONDON CITY AIRPORT

Aerodrome Standards Department, Safety Regulation Group
Civil Aviation Authority

1. INTRODUCTION

London City Airport was opened on 26 October 1987 and licensed in 1988. London City Airport is situated in a unique area and requires a unique regime for safeguarding its environment. A safeguarding model and map was produced and issued by the Civil Aviation Authority in 1988, which was based on a mixture of ICAO STOLPORT criteria and practical examples taken from the USA, Canada and Norway. This model, together with reference to ICAO Annex 14 and CAP 168 Licensing of Aerodromes criteria, identified suitable parameters upon which safeguarding surfaces for London City Airport would be based. The resulting surfaces were hybrid and were not directly related to CAP 168 criteria.

However, recent developments at and in the vicinity of the airport prompted a review by the CAA of the safeguarding surfaces and other relevant criteria for London City Airport.

2. PURPOSE

The purpose of this report is to identify and define the Obstacle Limitation Surfaces (OLS) and, where relevant, the safeguarding surfaces for London City Airport.

3. SCOPE

The surfaces described in this report substitute those that are stated in Chapter 4 of CAP 168, and will form a variation to the Aerodrome Licence. However, all other requirements specified in CAP 168 Chapter 4 shall remain applicable.

4. AERODROME SAFEGUARDING MAP (SCALE 1:50,000)

In accordance with the criteria detailed in this report, the London City Airport has produced an Aerodrome Safeguarding Map, which has been certified by the CAA. Copies of this map have been distributed to all relevant Local Planning Authorities and shall be used to identify planning applications which require consultation under the Town and Country Planning (Safeguarded Aerodromes, Protecting Sites and Military Explosive Storage Areas) Direction 2002, Circular 1/03 with London City Airport. This is achieved by using a colour-coded reference system.

It should be noted that the safeguarding map does not indicate the height of the safeguarded surfaces or any height limitations that may be imposed. It is used only as a means of determining whether London City Airport needs to be consulted on a planning application.

The safeguarding area extends to 10km from the mid-point of the runway.

An additional map has been produced for London City Airport that depicts the area in which London City Airport would need to consult with the Directorate of Airspace Policy (DAP) of the CAA should it wish to safeguard the Instrument Landing System (ILS) Obstacle Assessment Surfaces (see paragraph 7).

5. PROCEDURE FOR SAFEGUARDING LONDON CITY AIRPORT

Due to the complex nature of the Obstacle Limitation Surfaces surrounding London City Airport, which replace CAP 168 approach surfaces for both runways, the procedures for safeguarding the airport is divided into two stages.

Surfaces do not replace or assume a greater authority over each other; therefore, each surface should be assessed individually. When a site lies beneath more than one surface, the most limiting height shall be applied, unless in the opinion of the safeguarding authority safety would not be adversely affected.

STAGE 1 - SAFEGUARDING SURFACES ASSESSMENT (SURROUNDING AREA)

This stage involves the assessment of the proposed development with regard to the OLS surrounding the airport. The surrounding horizontal and related surfaces are established in respect of protection of the missed approach operations.

The basis for the elevations of each surface is the elevation datum of 4.95m AOD, (the elevation of the lowest landing threshold). They are illustrated in Annexes A and B and described as follows:

Transitional Surface

The transitional surface slope shall be 1:6 (16.7%), with its inner edge starting from the edge of the runway strip (75m from runway centreline; 60m beyond the runway end), to a height of 45m, where the inner horizontal surface is met.

Inner Horizontal Surface

A horizontal surface rectangular in shape at a height of 45 m above aerodrome reference, that extends laterally to a distance of 650 m on either side of the runway centreline and beyond the end of the runway strip to a distance of 1125 m from the inner edge of the take-off climb surface, at which point the take-off climb surface reaches a height of 45 m.

Flight Protection Surface – Runway 28

A surface sloping at 1:25 (4%), that lies in the same plane as the take-off climb surface but extends laterally beyond that surface, with the objective of providing an adequate margin during the climb out phase of the missed approach and emergency procedures, taking account of the anticipated lateral deviation during the procedure. The boundaries of this surface are as follows:

- An inner edge that lies along the outer edge of the 45 m horizontal surface at a range of 1125 m from the inner edge of the take-off climb surface and extending 650m either side of the runway centreline.
- Lateral boundaries that correspond with a 15% divergence on the south and at an angle of 60 degrees from the outer edge of the 45m horizontal surface on the north.
- An outer edge on the south where the 4% sloping surface reaches a height of 150m, at a range of 3750 m from the inner edge of the take-off climb surface and extending 1043.75 m from the runway centreline. An outer edge on the north where the 4% sloping surface reaches at height of 150m, at a range of 3750m from the inner edge, extending at an arc of radius 3750 to a point 60 degrees from the outer edge of the 45m horizontal surface.

Flight Protection Surface – Runway 10

A surface sloping at 1:25 (4%), that lies in the same plane as the take-off climb surface but extends laterally beyond that surface, with the objective of providing an adequate margin during the climb out phase of the missed approach and emergency procedures (for example, late go-around or engine failure after take-off), taking account of the anticipated lateral deviation during the procedure. The boundaries of this surface are as follows:

- An inner edge that lies along the outer edge of the 45 m horizontal surface at a range of 1125 m from the inner edge of the take-off climb surface and extending 650m either side of the runway centreline.
- Lateral boundaries that correspond with a 15% divergence to both the south and north, meeting the outer edge of the 45m horizontal surface on both sides.
- An outer edge where the 4% sloping surface reaches a height of 150m, at a range of 3750 m from the inner edge of the take-off climb surface and extending 1043.75 m either side of the runway centreline.

Outer Transitional Surface

- An outer transitional surface rising at a slope of 1 in 20 (5%) from the lateral boundary of the 45 m horizontal surface, throughout its length, to a height of 150 m and extending to a distance of 2750 m from the runway centreline perpendicular to that lateral boundary. At ranges of 1125 m and above beyond the inner edge of the take-off climb surface (i.e. beyond the line defined by the preceding sentence), the outer transitional surface is bounded by a line that joins the end of that line to the point at which the 4% sloping surface reaches a height of 150 m (the corner of its outer edge).

Outer Horizontal Surface

- The outer horizontal surface extends from the outer transitional surface at a height of 150m. The outer edge of the horizontal surface extends to a final limit of a 10,000m-circle radius centred on the Aerodrome Reference Point.
- In areas covered by both the 150 m outer horizontal surface and the take-off climb and approach surfaces, the requirements of the outer horizontal surface will apply as a minimum.

The proposed revised safeguarding regime is shown schematically in the following figure.

The following reference points illustrated at Annex A are defined as:

ARP: 542731E 180479N

Centre of Strip End (runway direction 10): 541918E 180496N

Centre of Strip End (runway direction 28): 543545E 180463N

STAGE 2 – SAFEGUARDING SURFACES ASSESSMENT (TAKE-OFF & CLIMB AND APPROACH SURFACES)

Take-Off and Climb Surfaces (TOCS)

This stage involves the assessment of the proposed development with regard to the Take-Off and Climb Surfaces (TOCS). The TOCS are illustrated at Annex C, and the dimensions are as follows:

Slope: 1:25 (4%)
Length: 3750m
Width: 150m (inner edge) to 1275m (outer edge)
Divergence: 15% (1:6.67)
Inner edge: From end of Take-Off Distance Available (TODA)
Grid reference for the end of TODA on the extended runway centreline:
Runway 10 – 543296E 180467N
Runway 28 – 542100E 180494N

Approach Surfaces (APPS)

The APPS are also illustrated at Annex D, and the dimensions are as follows:

Slope: 1:20 (5%)
Length: 10000m overall (6000m + 4000m horizontal). From this point the surface will extend out to 10,000m surface limits at a horizontal level surface of 300m.
Width: 150m (inner edge) to 1950m (outer edge).
Divergence: 15% (1:6.67)
Inner edge: On the extended runway centreline 60m prior to the landing threshold
Grid reference of threshold:
Runway 10 – 542077E 180494N
Runway 28 – 543411E 180464N

6. SAFEGUARDING OAS (ILS) ASSESSMENT

This assessment is not part of SRG's remit; however, if an assessment with regard to the Obstacle Assessment Surfaces (OAS) for the ILS is desired, any proposed development within the defined OAS assessment area (see Annex E) that is 45m or greater in height above the lowest runway threshold shall be referred by London City Airport to the Terminal Airspace Section of DAP for further investigation of any effect on the ILS.

The grid references for the OAS assessment area are:

NE corner: 548119.30E 181121.34N
SE corner: 548095.92E 179665.53N
SW corner: 537231.38E 179840.02N
NW corner: 537254.76E 181295.83N

Note 1: DAP should be notified if it is known that, despite an objection being lodged because of an infringement of an OLS, a development has been granted planning permission.

Note 2: London City Airport should ensure that the OAS assessment criteria are current. Grid references (in OSGB) given in this document refer to survey dated December 2002.

7. IMPLEMENTATION AND CONCLUSIONS

Due to pressures to maximise building opportunities to develop the area, it is vital that the Obstacle Limitation Surfaces surrounding London City Airport are protected in order to ensure safe aircraft operations, through the protection of the airspace surrounding London City Airport.

Should a proposed development infringe any of the stated levels for the surfaces included in this document, an assessment of the potential impact of that development is required. Should an assessment indicate an impact on aircraft operations, an “objection” should be issued.

Please be advised the information provided within this document may change without notice. If you require the latest issue please contact the Safeguarding Consultee at London City Airport on 020 7646 0255, or 0207 646 0200.

ANNEX A

LONDON CITY SAFEGUARDED ASSESSMENT SURFACES – PLAN VIEW

The safeguarding regime is shown schematically in the following figure:

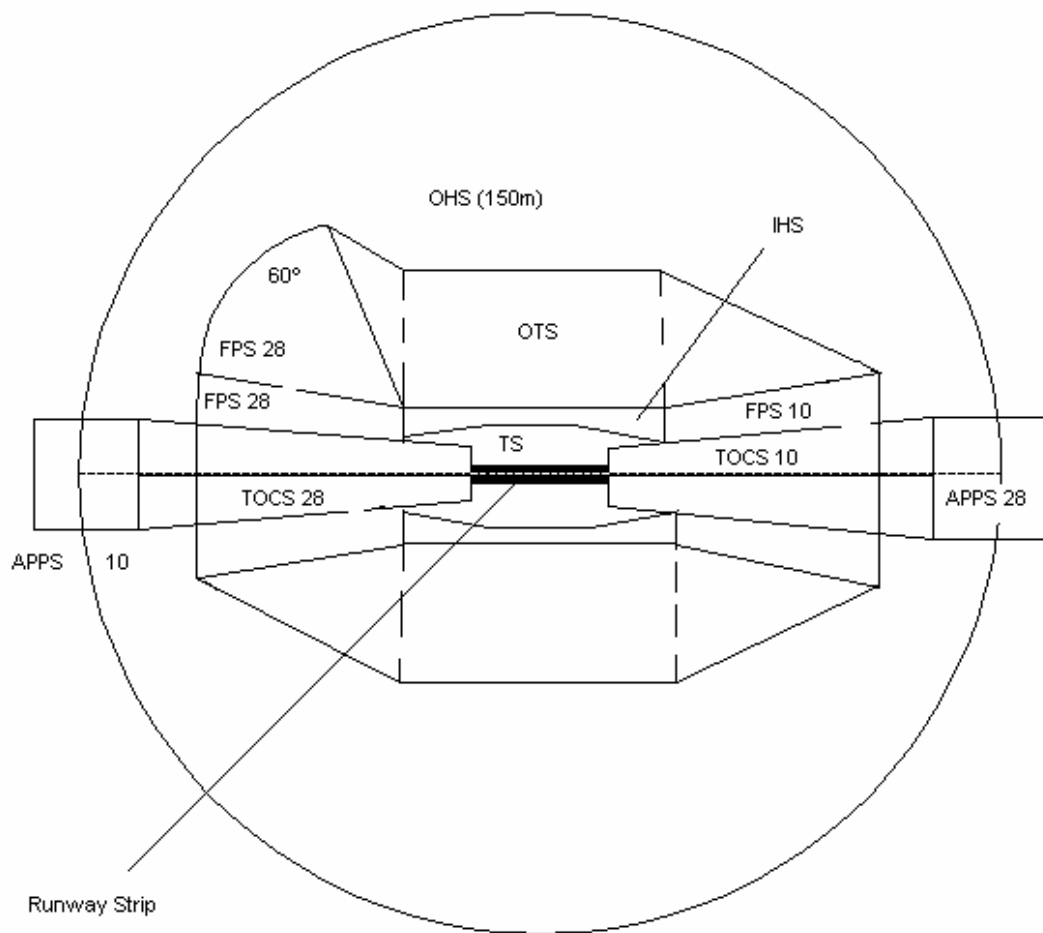

London City Safeguarded Assessment Surfaces - Cross-Section Through Runway

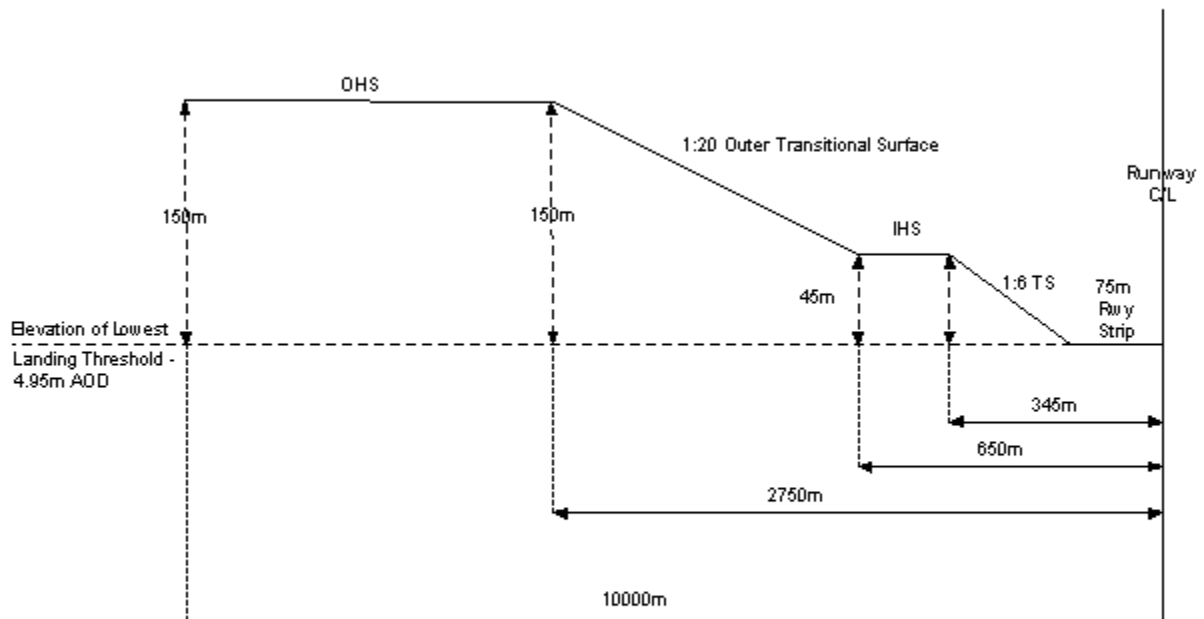

Not to Scale

Annex B

London City Safeguarded Assessment Surfaces - Take-Off and Climb

Profile

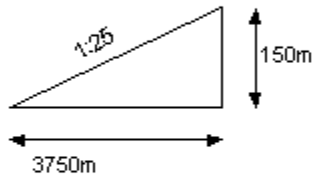

Plan

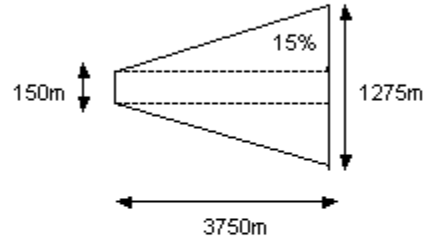

Not to Scale

Annex C

London City Safeguarded Assessment Surfaces - Approach

Profile

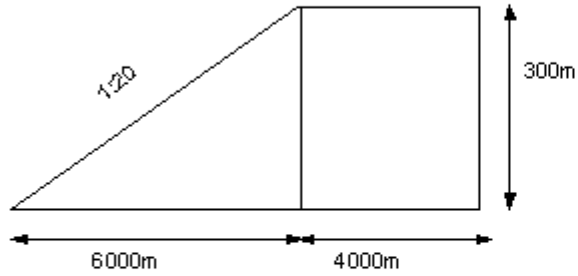

Plan

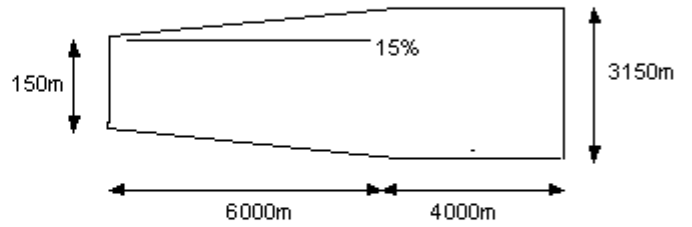

Not to Scale

Annex D

The final width of the APPS should read 1950m not 3150m

Annex E

DAP Assessment Coverage Diagram

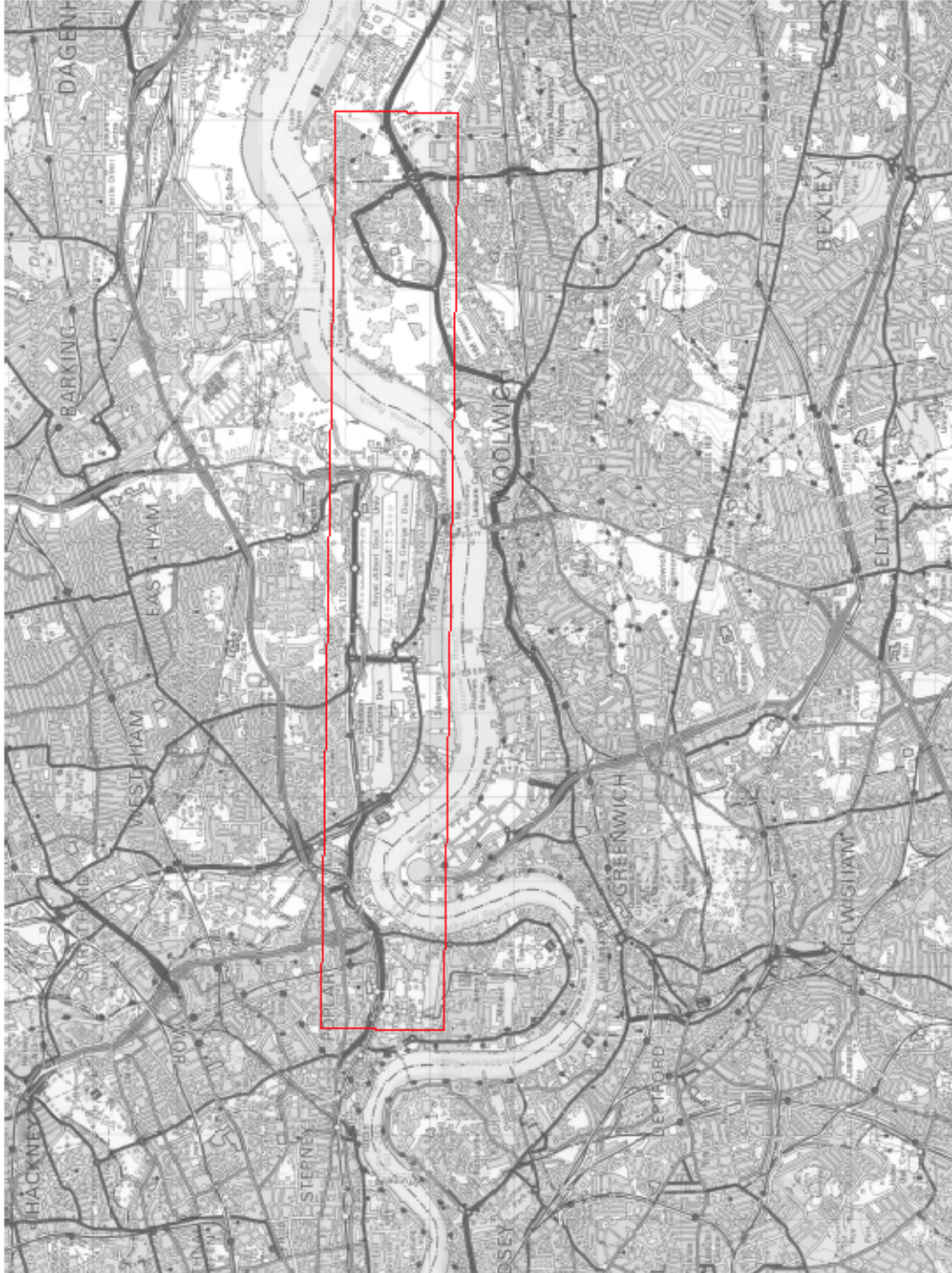

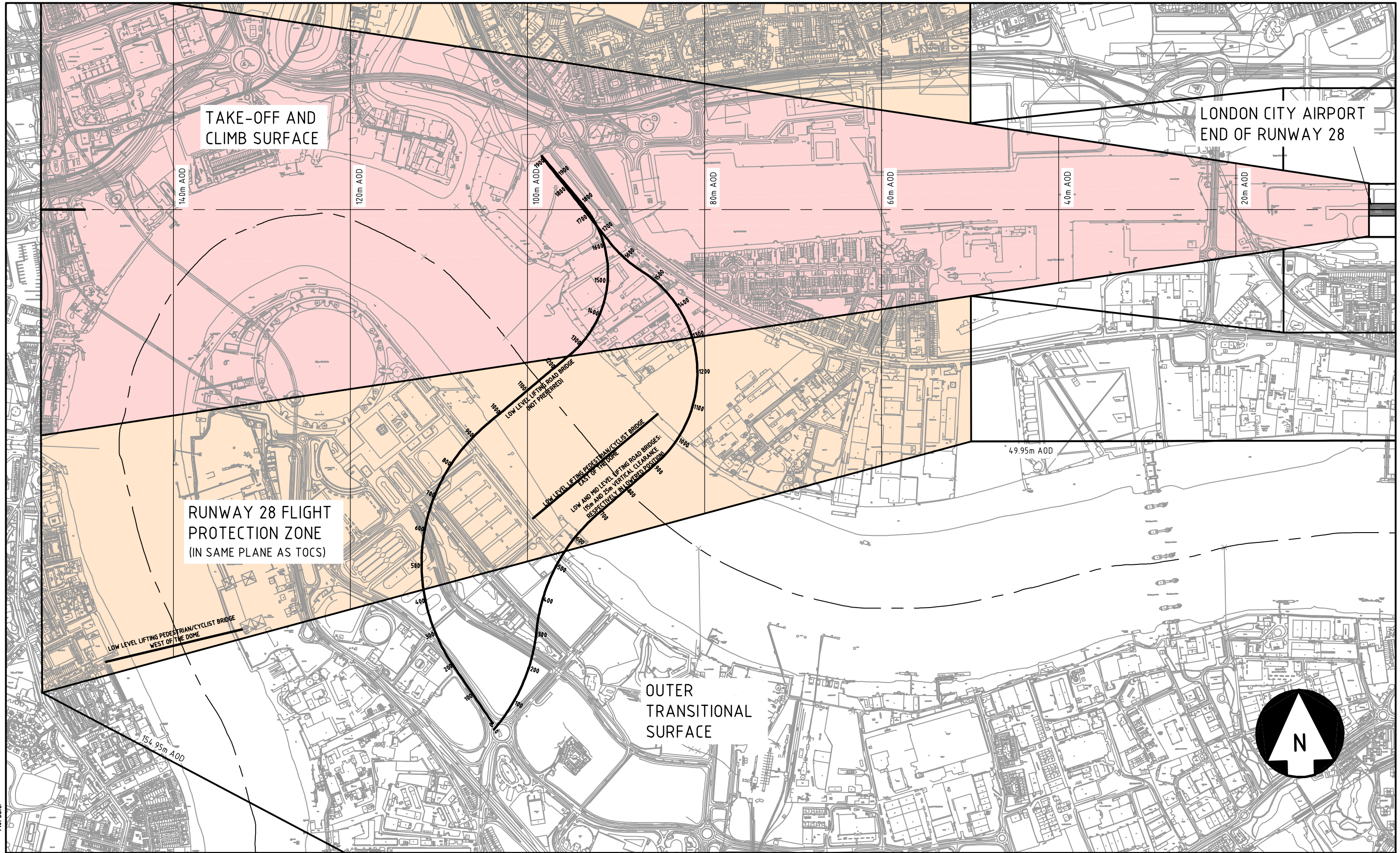

Plot Date:

Issue	Description	Auth.	Ckd.	Appd.	Date
01	INITIAL ISSUE	TB	TB	PT	07/04/09

Notes	

Client



Transport for London
Windsor House
42 - 50 Victoria Street
London
SW1H 0TL

Scale A3
1:10000 @ A3

Datum
LOCAL

Project

NEW THAMES CROSSINGS

Title

**LONDON CITY AIRPORT AVIATION CLEARANCES
LOW LEVEL BRIDGES
PLAN**



HYDER CONSULTING (UK) Ltd
29 Bressenden Place
London
SW1E 5DZ
Tel: +44 (0)20 7316 6000
Fax: +44 (0)20 7316 6125

Drawing No.

F001-LN01198-LND

Issue

01

CAD Ref:

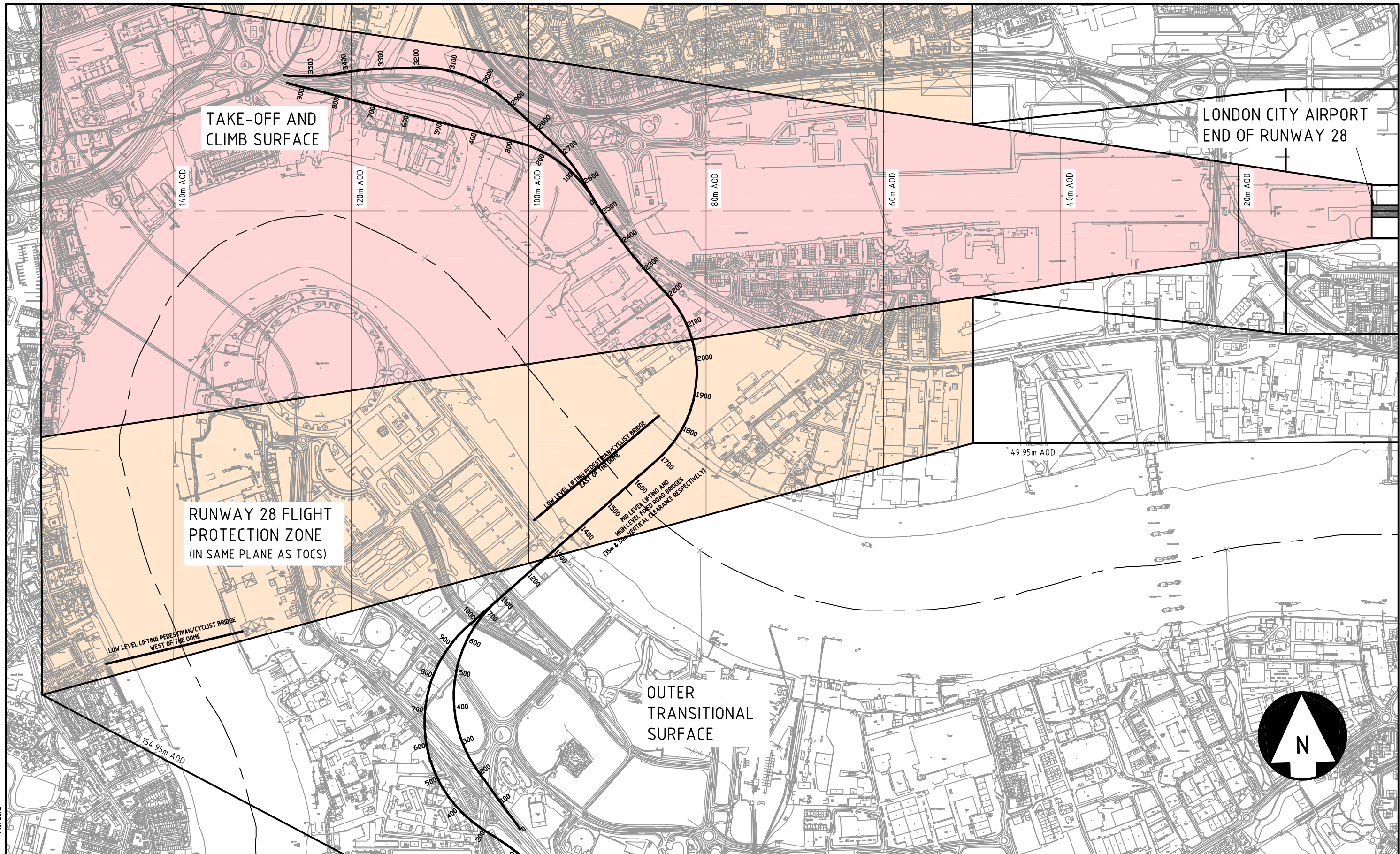

Plot Date:

CAD Ref:

Issue	Description	Auth.	Ckd.	Appd.	Date
01	INITIAL ISSUE	TB	TB	PT	07/04/09

Notes	

Client



Transport for London
Windsor House
42 - 50 Victoria Street
London
SW1H 0TL

Scale A3
1:10000 @ A3

Datum
LOCAL

Project

NEW THAMES CROSSINGS

Title

LONDON CITY AIRPORT AVIATION CLEARANCES HIGH LEVEL BRIDGES PLAN



HYDER CONSULTING (UK) Ltd
29 Bressenden Place
London
SW1E 5DZ
Tel: +44 (0)20 7316 6000
Fax: +44 (0)20 7316 6125

Drawing No.

F002-LN01198-LND

Issue

01

LOW LEVEL LIFTING
PEDESTRIAN/CYCLE BRIDGE
WEST OF THE DOME

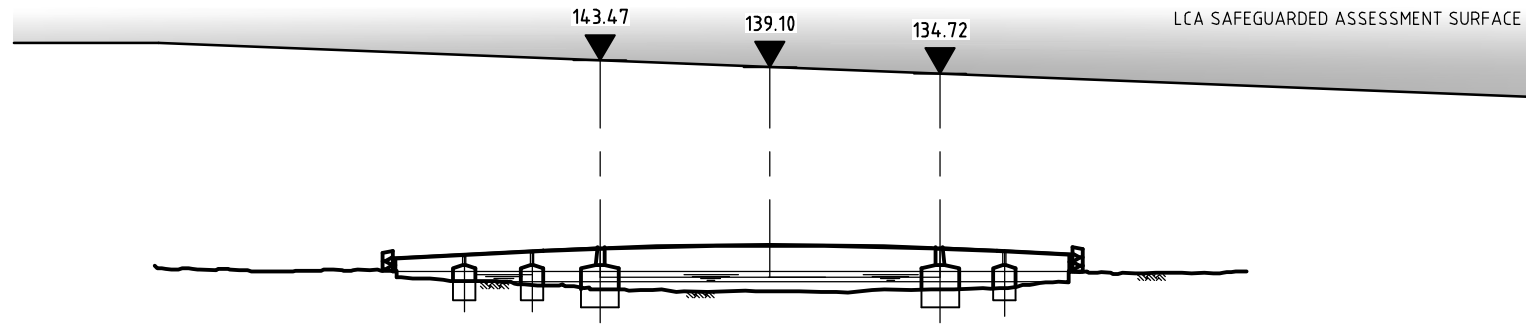

LOW LEVEL LIFTING ROAD
(NOT PREFERRED)

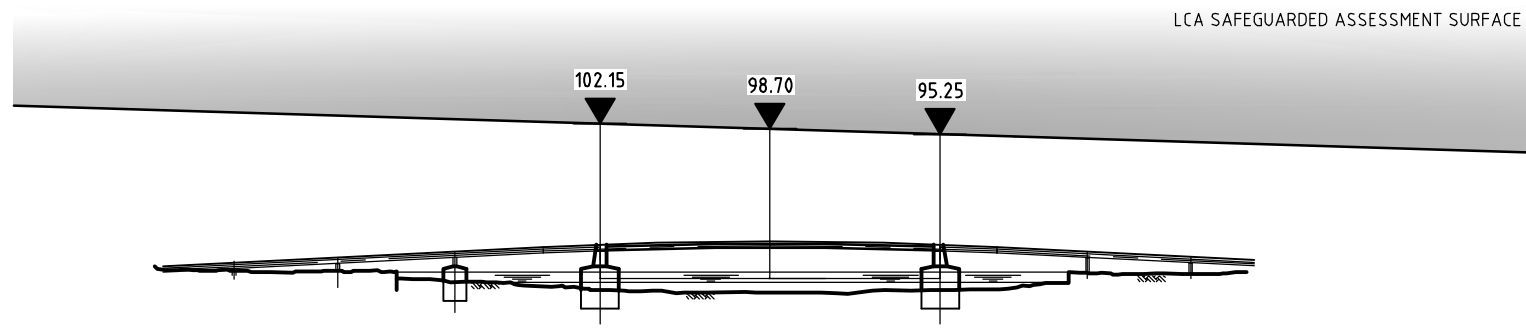

LOW LEVEL LIFTING
PEDESTRIAN/CYCLE BRIDGE
EAST OF THE DOME

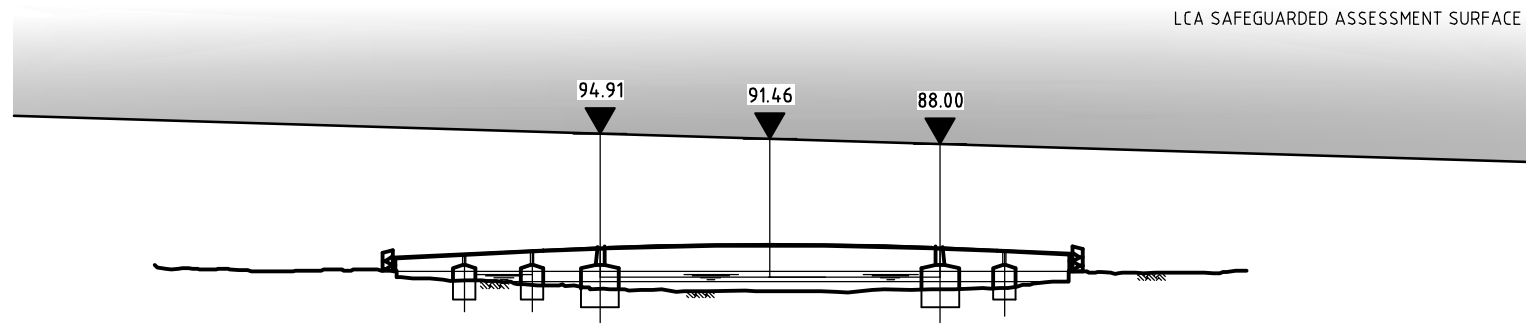

LOW AND MID LEVEL LIFTING
ROAD BRIDGES

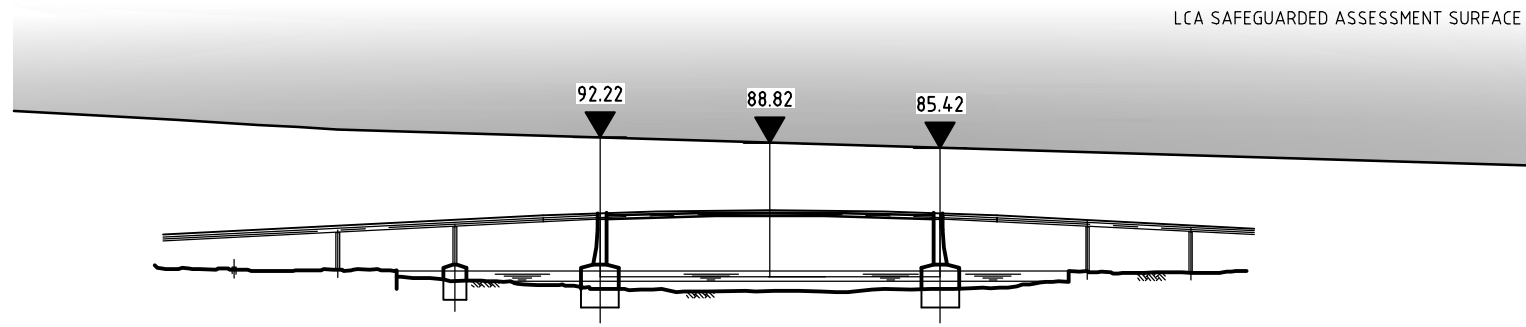

MID LEVEL LIFTING AND HIGH
LEVEL FIXED ROAD BRIDGES

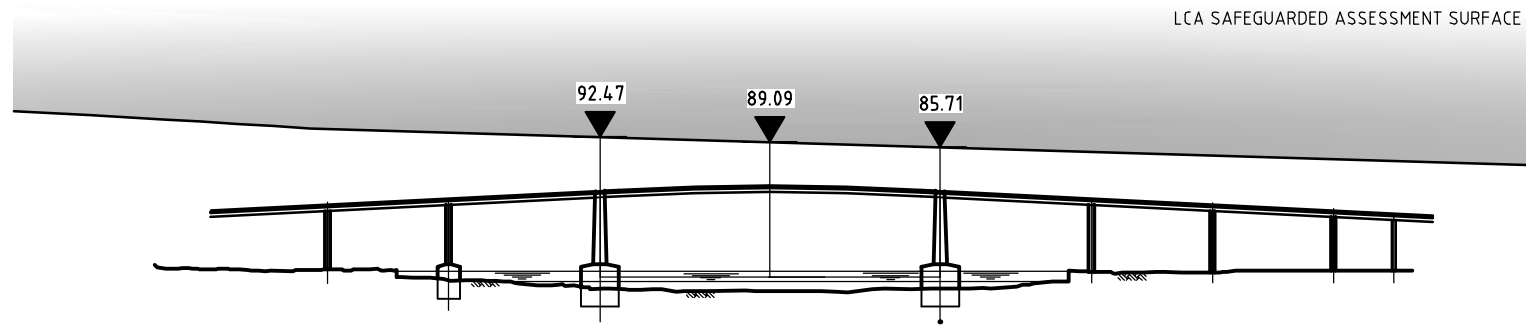

Plot Date:

01	INITIAL ISSUE	TB	TB	PT	07/04/09
Issue	Description	Auth.	Ckd.	Appd.	Date

Notes

Client



Transport for London
Windsor House
42 - 50 Victoria Street
London
SW1H 0TL

Scale A3
1:10000 @ A3

Datum
LOCAL

Project

NEW THAMES
CROSSINGS

Title

LONDON CITY AIRPORT
AVIATION CLEARANCES
BRIDGE ALIGNMENT SECTIONS



HYDER CONSULTING (UK) Ltd
29 Bressenden Place
London
SW1E 5DZ
Tel: +44 (0)20 7316 6000
Fax: +44 (0)20 7316 6125

Drawing No.

F003-LN01198-LND

Issue

01

Appendix 4

Protected and Local Views



1. Designated View from Greenwich Park - London Panorama Designated View 5A.1 (LVMF)



2. Designated View from Greenwich Park - London Panorama Designated View 5A.2 (LVMF)



3. Designated View from Blackheath Point - London Panorama Designated View 6 (LVMF)

March 2009 - NH - LN01198

Sheet 1 - Third Thames Crossing - Visual Appraisal - Designated Views





4. View from east side of Greenwich Peninsula looking north



5. View from Greenwich World Heritage Site, north west of Old Royal Naval College, looking north



6. View from Thames Barrier Park looking at panorama from flood barrier to O2

March 2009 - NH - LN01198

Sheet 2 - Third Thames Crossing - Visual Appraisal - Typical Local Views



7. View from Silvertown, 500m west of Woolwich Ferry, looking west from industrial



8. View from south east of Isle of Dogs looking north



9. View looking west from Woolwich Ferry south side terminal



10. View from east side of Isle of Dogs looking north

March 2009 - NH - LN01198

Sheet 3 - Third Thames Crossing - Visual Appraisal - Typical Local Views



Appendix 5

Highway Alignments for main options

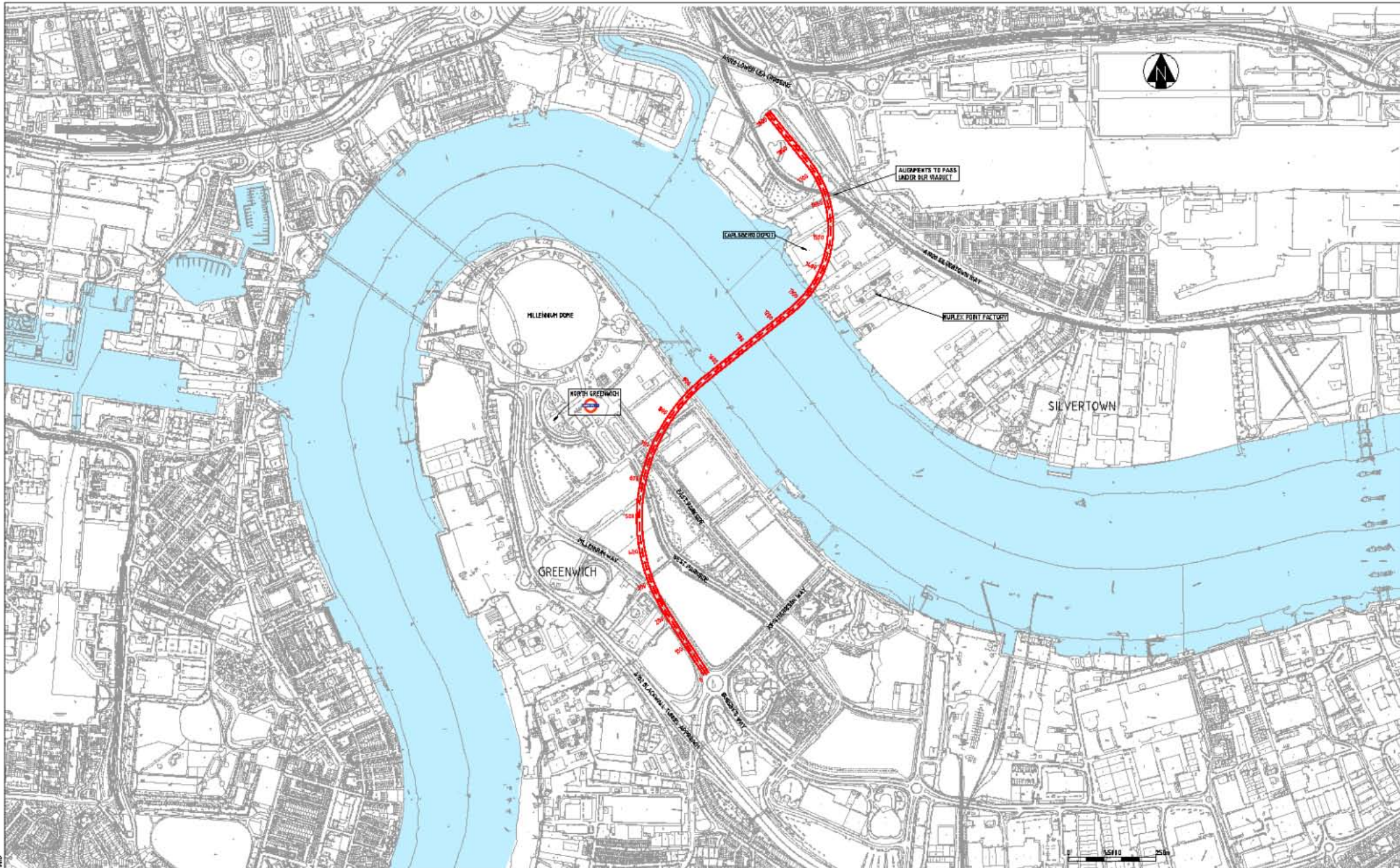

Notes
 KEY:
 LOW LEVEL LIFTING ROAD BRIDGE (NOT PREFERRED) - SINGLE CARRIAGEWAY

Rev No	Description	Drawn	Auth	Ord.	Appd.	Date
03	DRAWING NUMBER CHANGED FROM BREL-LN0198-GDD-02	CK	RH	RH	PT	16.06.05
02	MINOR AMENDATION PRELIMINARY	EM	RH	RH	PT	10.06.05
01	INITIAL ISSUE	EM	RH	RH	PT	06.04.05

Client

 Transport for London
 Windsor House
 42 - 58 Victoria Street
 London
 SW1H 0FL

Scale (All) 1:5000 @ A1
 1:10000 @ A3

Status

Project
NEW THAMES CROSSINGS

Title **LOW LEVEL LIFTING ROAD BRIDGE 15m VERTICAL CLEARANCE IN LOWERED POSITION (NOT PREFERRED) PLAN LAYOUT**

 Hyder Consulting

HYDER CONSULTING (UK) LTD
 29 Broadwater Place
 London
 SW1E 5JZ
 Tel: +44 (0)20 7266 6800
 Fax: +44 (0)20 7266 4625

Drawing No. H001-LN01198-GDD

Issue 03

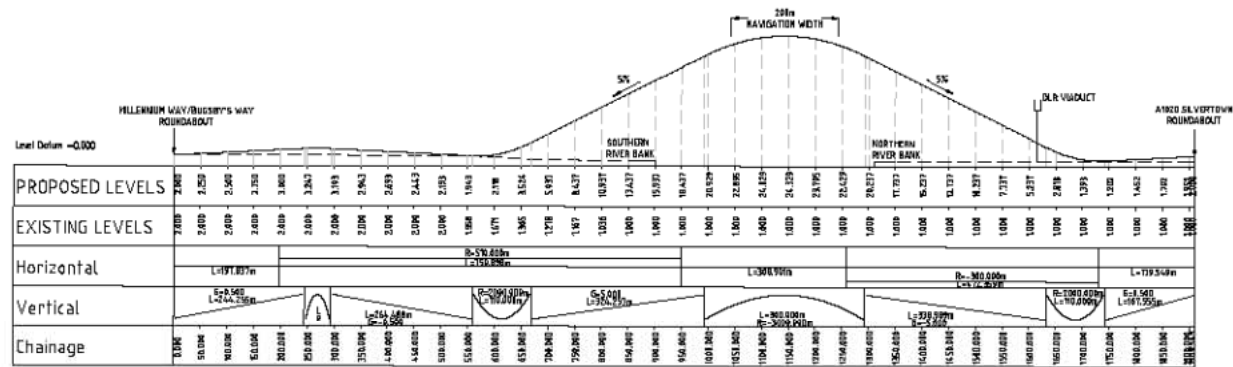

LOW LEVEL LIFTING ROAD BRIDGE
 15m VERTICAL CLEARANCE IN LOWERED POSITION
 [NOT PREFERRED]
 SCALE: H=1:1000, V=1:100 @ A1

DWG NO.

Notes						
02	DRAWING NUMBER CHANGED FROM GDD-1401198-GDD-01	DK	RS	RH	PT	15.06.01
01	INITIAL ISSUE	DK	RS	RH	PT	08.04.00
Issue	Description	Draw	Auth.	Chk.	Appd.	Date

Client



Transport for London
 Mindero House
 12 - 50 Victoria Street
 London
 SW9H 9FL

Scale: 1:A3
 H=1:1000 @ A1
 V=1:100 @ A1

Date

Project

NEW THAMES CROSSINGS

TITLE LOW LEVEL LIFTING ROAD BRIDGE 15m VERTICAL CLEARANCE IN LOWERED POSITION [NOT PREFERRED] LONG SECTION



HYDER CONSULTING (UK) Ltd
 28 Brinsford Place
 London
 SW1E 5DZ
 Tel: +44 (0)20 7796 6400
 Fax: +44 (0)20 7796 6425

Consulting

Drawing No. H002-LN01198-GDD Issue 02

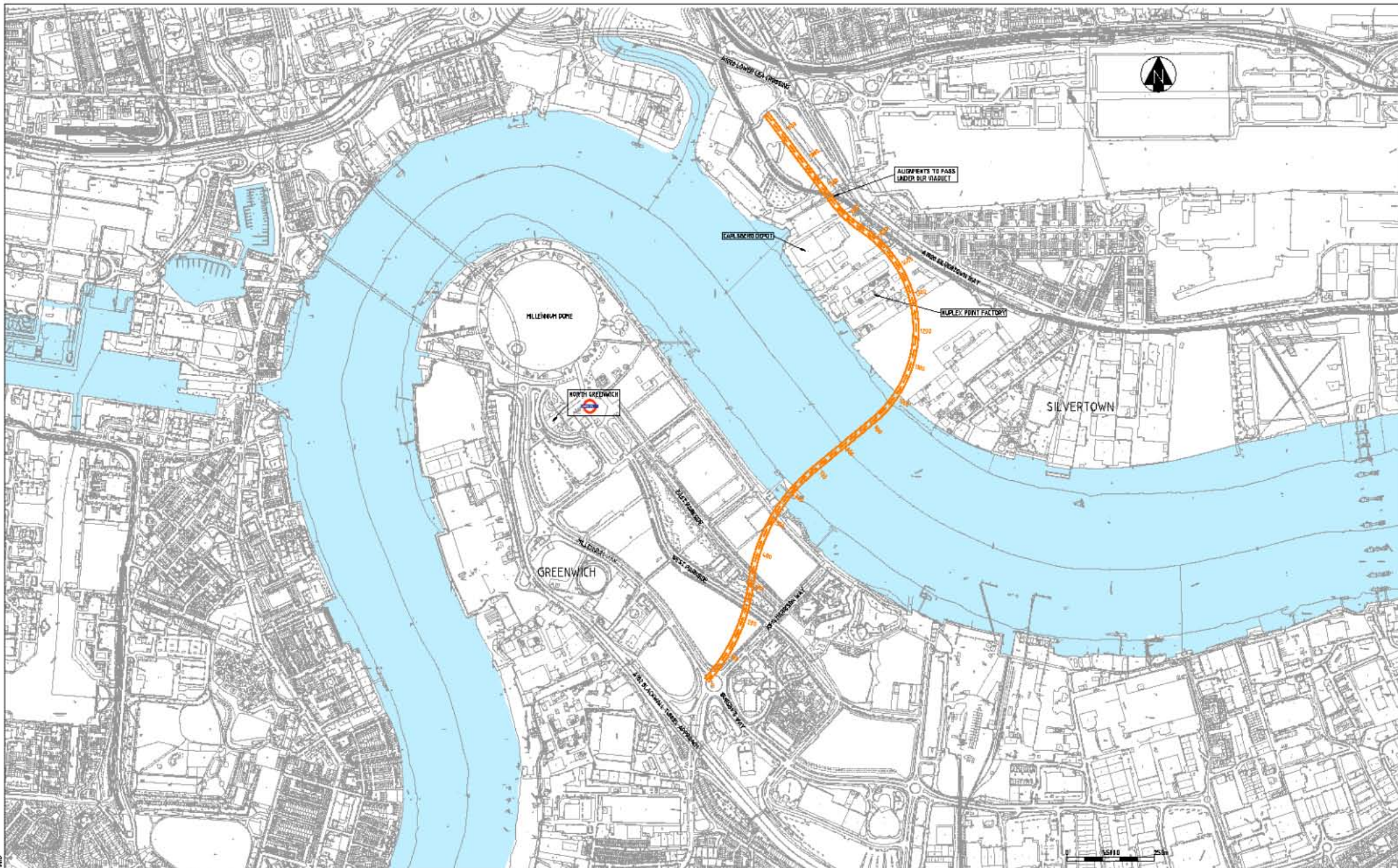

KEY

LOW AND MID LEVEL LIFTING ROAD BRIDGES: 15m AND 25m VERTICAL CLEARANCE RESPECTIVELY IN LOWERED POSITION - SINGLE CARRIAGEWAY

Issue	Description	Drawn	Asst.	Chk.	Appd.	Date
01	ISSUES WHICH CHANGED FROM 001-14/10/02	DK	RH	RH	PT	19.04.01
02	MINOR AMENDMENT/CHANGES	EM	RH	RH	PT	30.04.05
03	INITIAL ISSUE	EM	RH	RH	PT	04.04.03

Client



Transport for London
Windsor House
42 - 58 Victoria Street
London
SW1H 0TL

Scale (All)
1:5000 @ A1
1:10000 @ A3

Status

Project

NEW THAMES CROSSINGS

Title
LOW & MID LEVEL LIFTING ROAD BRIDGES 15m AND 25m VERTICAL CLEARANCE IN LOWERED POSITION PLAN LAYOUT



HYDER CONSULTING (UK) Ltd
29 Grosvenor Place
London
SW1E 7EQ
Tel: +44 (0)20 7946 4000
Fax: +44 (0)20 7946 4125

Consulting

Drawing No.
H003-LN01198-GDD

Issue
03

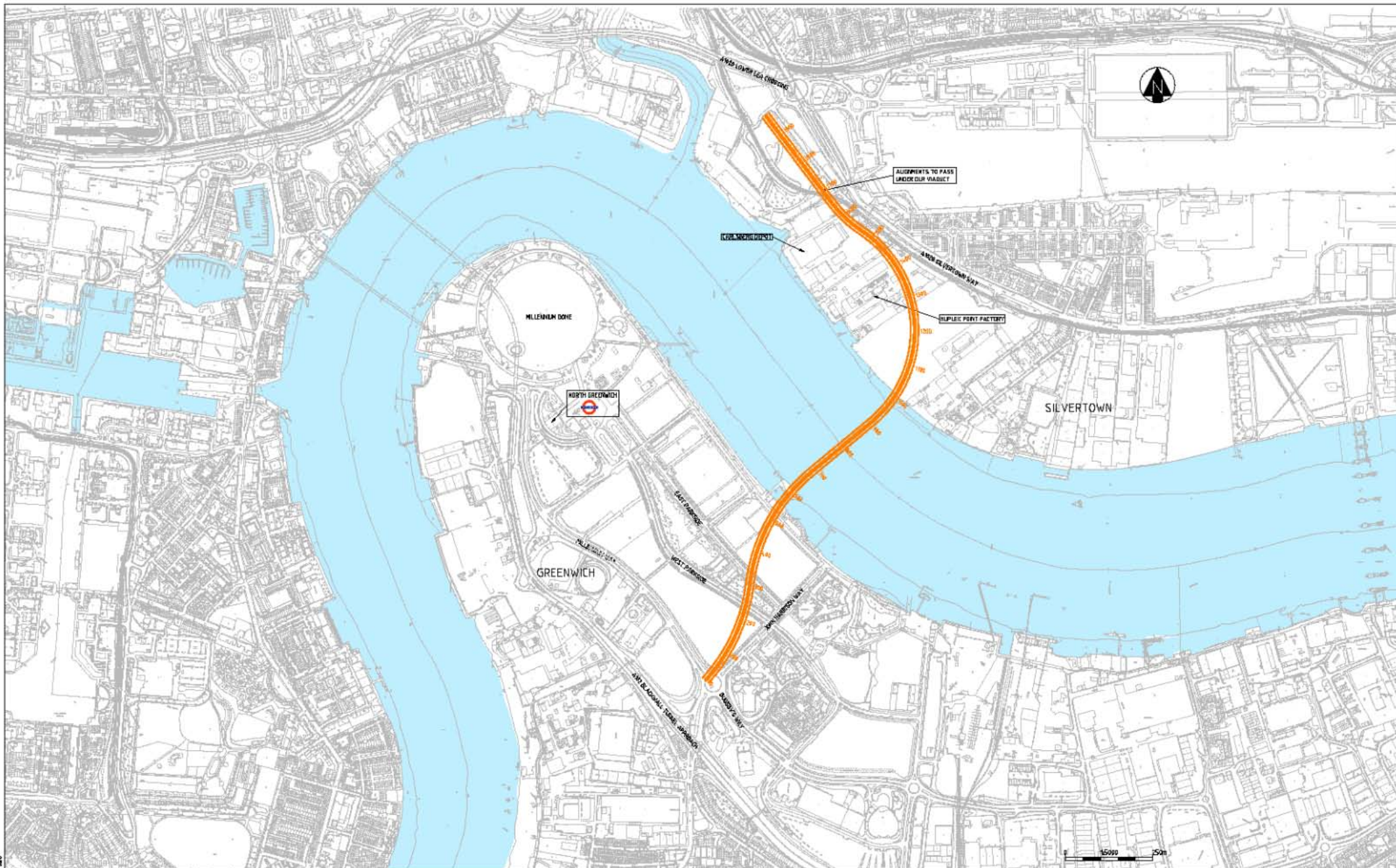

Notes

KEY

 MID LEVEL LIFTING ROAD BRIDGE (DUAL CARRIAGEWAY)
25m VERTICAL CLEARANCE IN LOWERED POSITION

No	Description	Drawn	Auth.	Chk.	Appd.	Date
02	DRAMA THAMES CROSSING FROM DND-L-NORTH-022-01	DK	RI1	RI1	PT	11.06.09
01	INITIAL ISSUE	EM	RI1	RI1	PT	06.05.09

Client



Transport for London
Mindar House
42 - 50 Victoria Street
London
SW1N 8TL

Scale

1:5000 @ A1
1:10000 @ A3

Sheet

02

Project

NEW THAMES
CROSSINGS

MID LEVEL LIFTING ROAD BRIDGE
(DUAL CARRIAGEWAY) 25m VERTICAL
CLEARANCE IN LOWERED POSITION
PLAN LAYOUT



HYDER CONSULTING (UK) LTD
28 Brackendon Place
London
SW1E 5JZ
Tel: +44 (0)20 7396 6000
Fax: +44 (0)20 7396 6025

Drawing No.

H004-LN01198-GDD

Issue

02

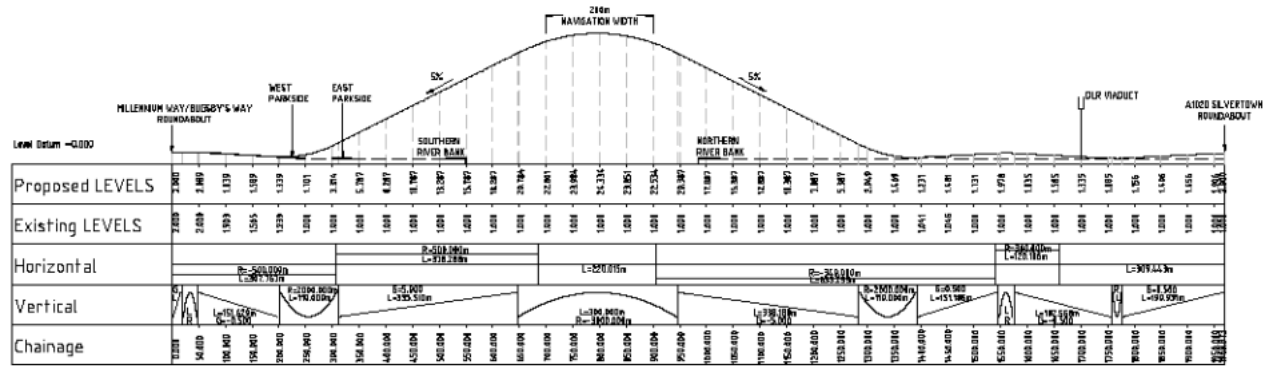

LOW LEVEL LIFTING BRIDGE
15m VERTICAL CLEARANCE IN LOWERED POSITION (SINGLE CARRIAGEWAY)

SCALE H-1:5000 V-1:500 @ A3
SCALE H-1:1000 V-1:500 @ A1

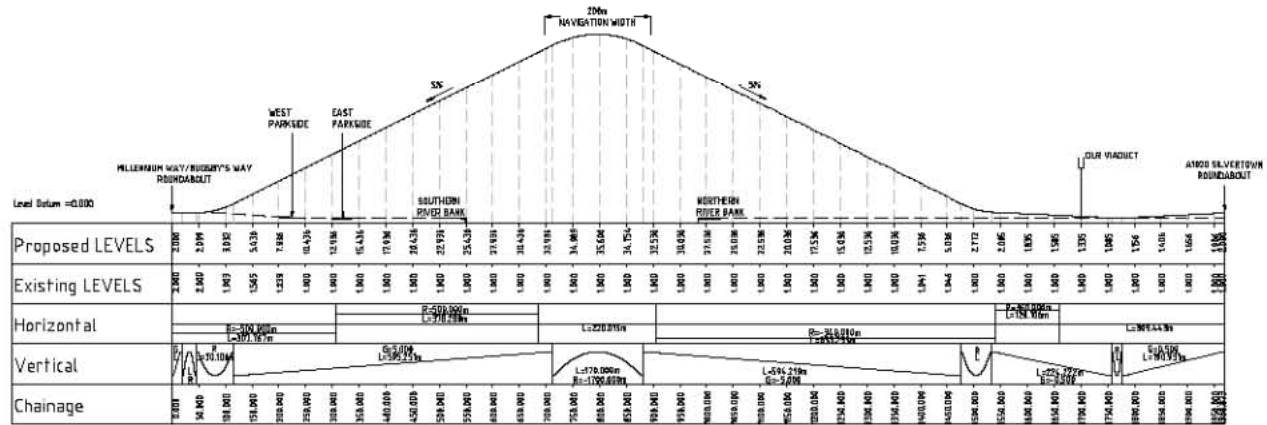

MID LEVEL LIFTING BRIDGE
25m VERTICAL CLEARANCE IN LOWERED POSITION (SINGLE CARRIAGEWAY)

SCALE H-1:5000 V-1:500 @ A3
SCALE H-1:1000 V-1:500 @ A1

DWG NO.

		Notes				
02	DESIGNS UPDATED CHANGES FROM SHEET L00196-GDD-01	DK	RH	DH	PT	19.06.07
01	INITIAL ISSUE	EH	RS	RH	PT	08.04.05
Issue	Description	Drawn	Auth.	Chk.	Appd.	Date

Client



Transport for London
Mindor House
42 - 50 Victoria Street
London
SW1N 0TL

Scale: H:1:5
H-1:5000 @ A3
V-1:500 @ A1

Sheet

Project

NEW THAMES CROSSINGS

TIME LOW & MID LEVEL LIFTING ROAD BRIDGES 15m AND 25m VERTICAL CLEARANCE IN LOWERED POSITION LONG SECTIONS



HYDER CONSULTING (UK) LTD
28 Brinsford Place
London
SW1E 5DZ
Tel: +44 (0)20 7796 4400
Fax: +44 (0)20 7796 4425

Consulting

Drawing No. H005-LN01198-GDD

Issue 02

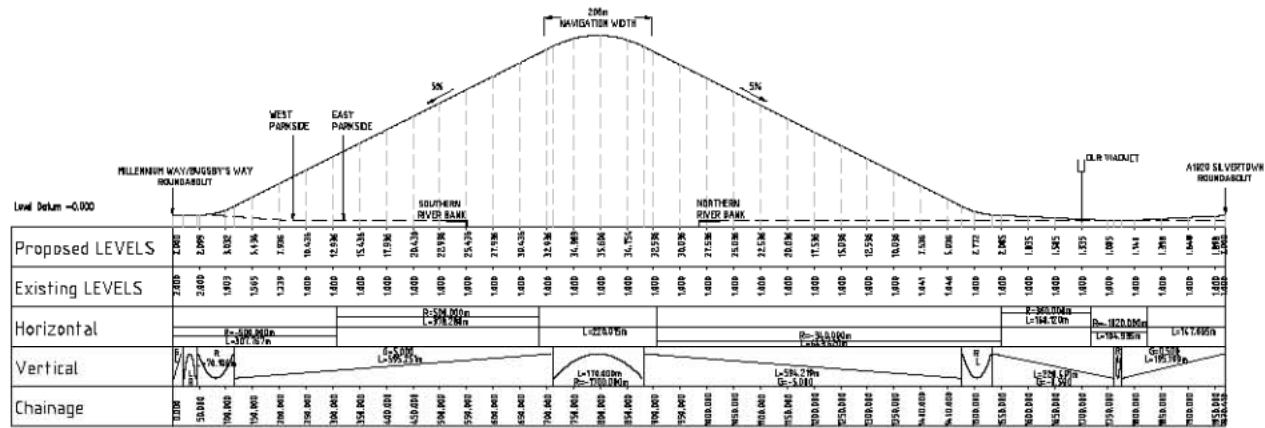

MID LEVEL LIFTING BRIDGE (DUAL CARRIAGEWAY)
 25m VERTICAL CLEARANCE IN LOWERED POSITION
 SCALE: H=1:500, V=1:50 @ A3
 SCALE: H=1:1000, V=1:500 @ A1

DWG NO.

Issue	Description	Drawn	Auth.	Chk.	Appd.	Date
02	DRAWING NUMBER CHANGED FROM E13-14791-GDD-01	DK	RH	RH	PT	19/04/19
01	INITIAL ISSUE	EM	RF	RH	PT	08/05/18

Notes

Client



Transport for London
 Mindor House
 42 - 50 Victoria Street
 London
 SW1N 0TL

Scale: A3
 H=1:500 @ A1
 V=1:500 @ A1

Sheet

Project

NEW THAMES CROSSINGS

T16 MID LEVEL LIFTING ROAD BRIDGE (DUAL CARRIAGEWAY) 25m VERTICAL CLEARANCE IN LOWERED POSITION LONG SECTION



HYDER CONSULTING (UK) Ltd
 28 Brunsden Place
 London
 SW1E 5DZ
 Tel: +44 (0)20 7396 4400
 Fax: +44 (0)20 7396 4425

Consulting

Drawing No. H006-LN01198-GDD

Issue 02

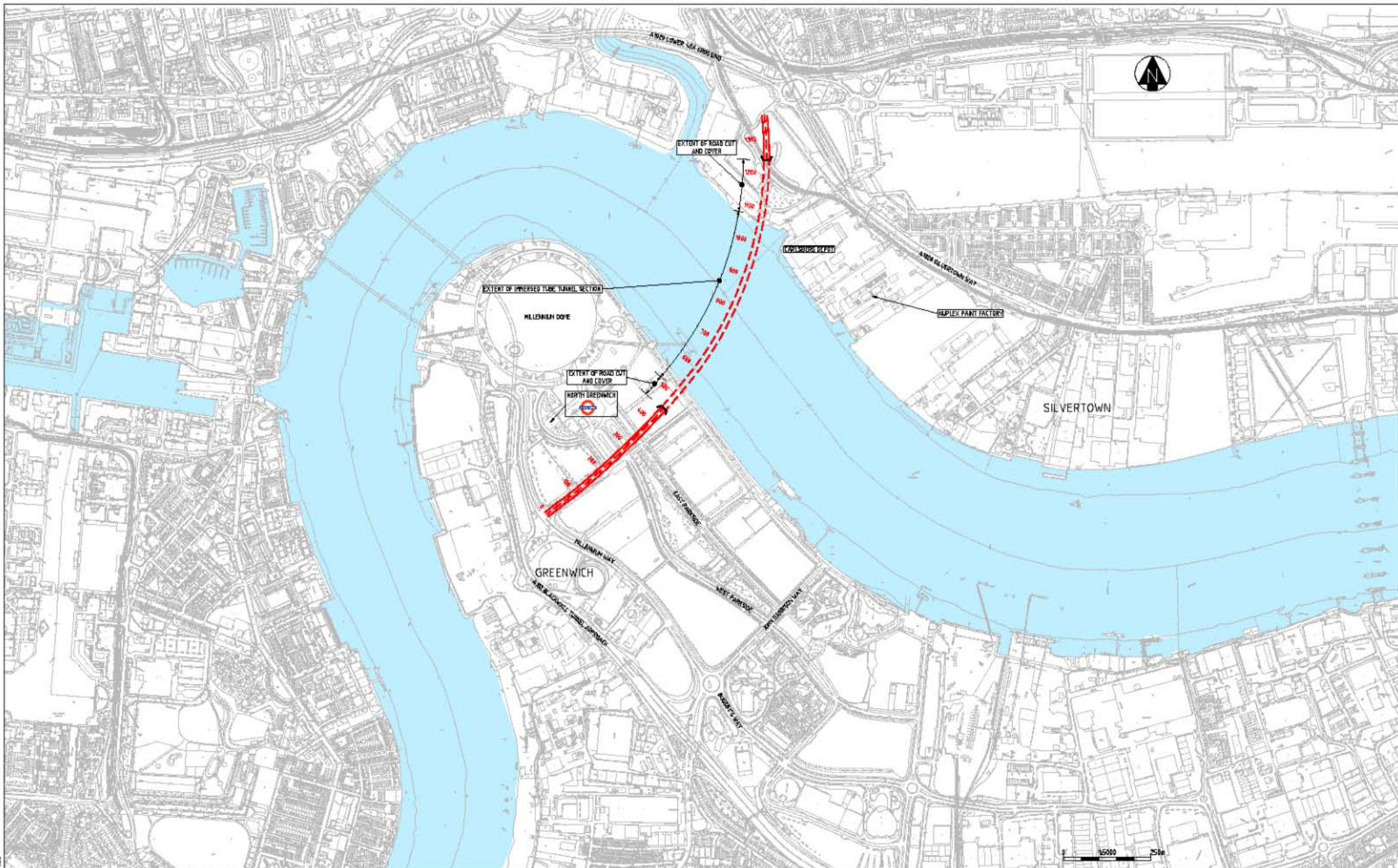

Notes

KEY

————— NORTHERN CORRIDOR ALIGNMENT A1 (SINGLE CARRIAGEWAY)

——— NORTHERN PORTAL

Issue	Description	Drawn	Auth.	Chd.	Appd.	Date
02	AMEND CUT AND COVER DIMENSIONS	RH	RS	RH	PT	16.07.09
04	CHANGE NUMBER CHANGED FROM GDD-LM198-GDD-03	DK	RS	RH	PT	19.06.09
03	AMENDED TO INCLUDE NORTHERN CORRIDOR	EM	RS	RH	PT	05.06.09
02	PROVIDE AMENDMENT AMENDMENTS	EM	RS	RH	PT	23.04.09
01	INITIAL ISSUE	EM	RS	RH	PT	08.04.09

Client



Transport for London
Mindor House
42 - 50 Victoria Street
London
SW1N 0TL

Scale IAB
1:5000 @ A1
1:10000 @ A3

Date

Project

NEW THAMES CROSSINGS

Title

**IMMERSED TUBE TUNNEL
NORTHERN CORRIDOR ALIGNMENT A1
SINGLE CARRIAGEWAY
PLAN LAYOUT**



Hyder Consulting

HYDER CONSULTING (UK) Ltd
28 Brackenham Place
London
SW1E 5DZ
Tel: +44 (0)20 7396 8400
Fax: +44 (0)20 7396 8425

Drawing No.

H007-LN01198-GDD

Issue

05

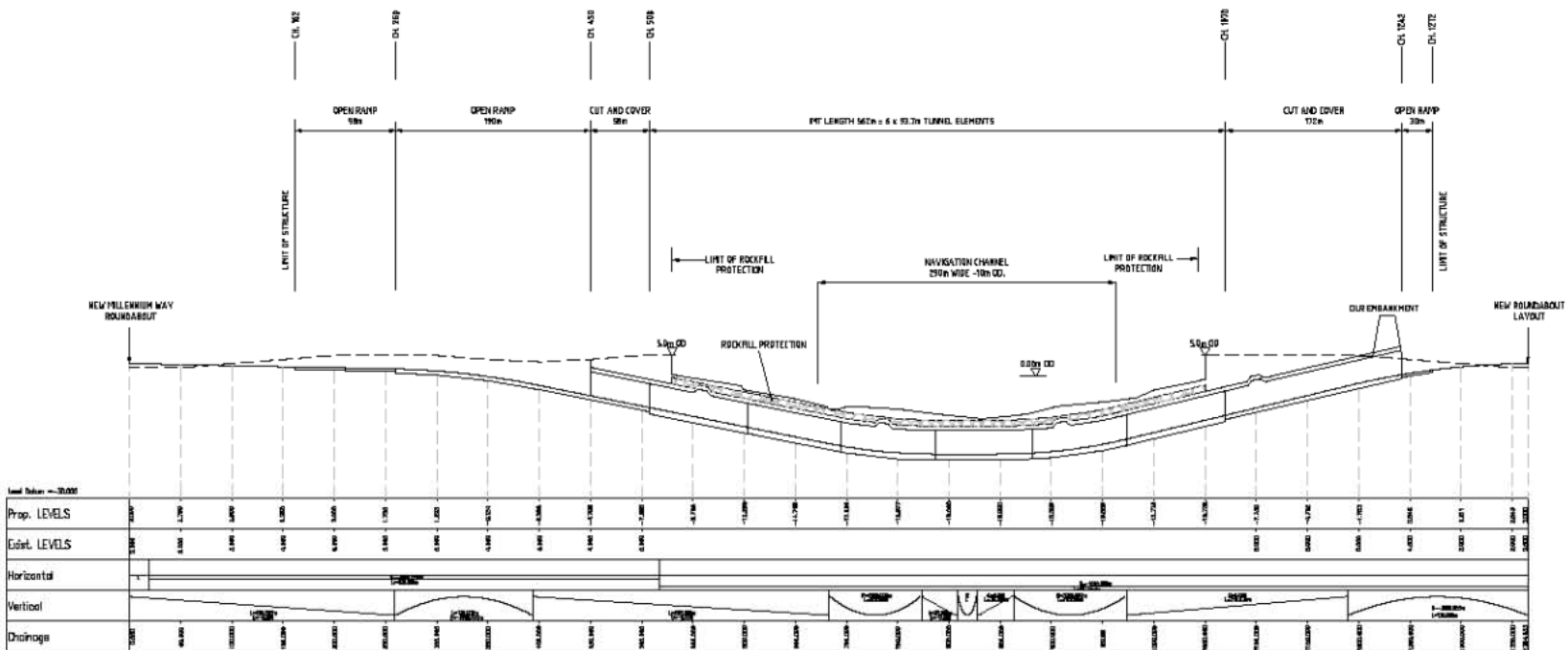

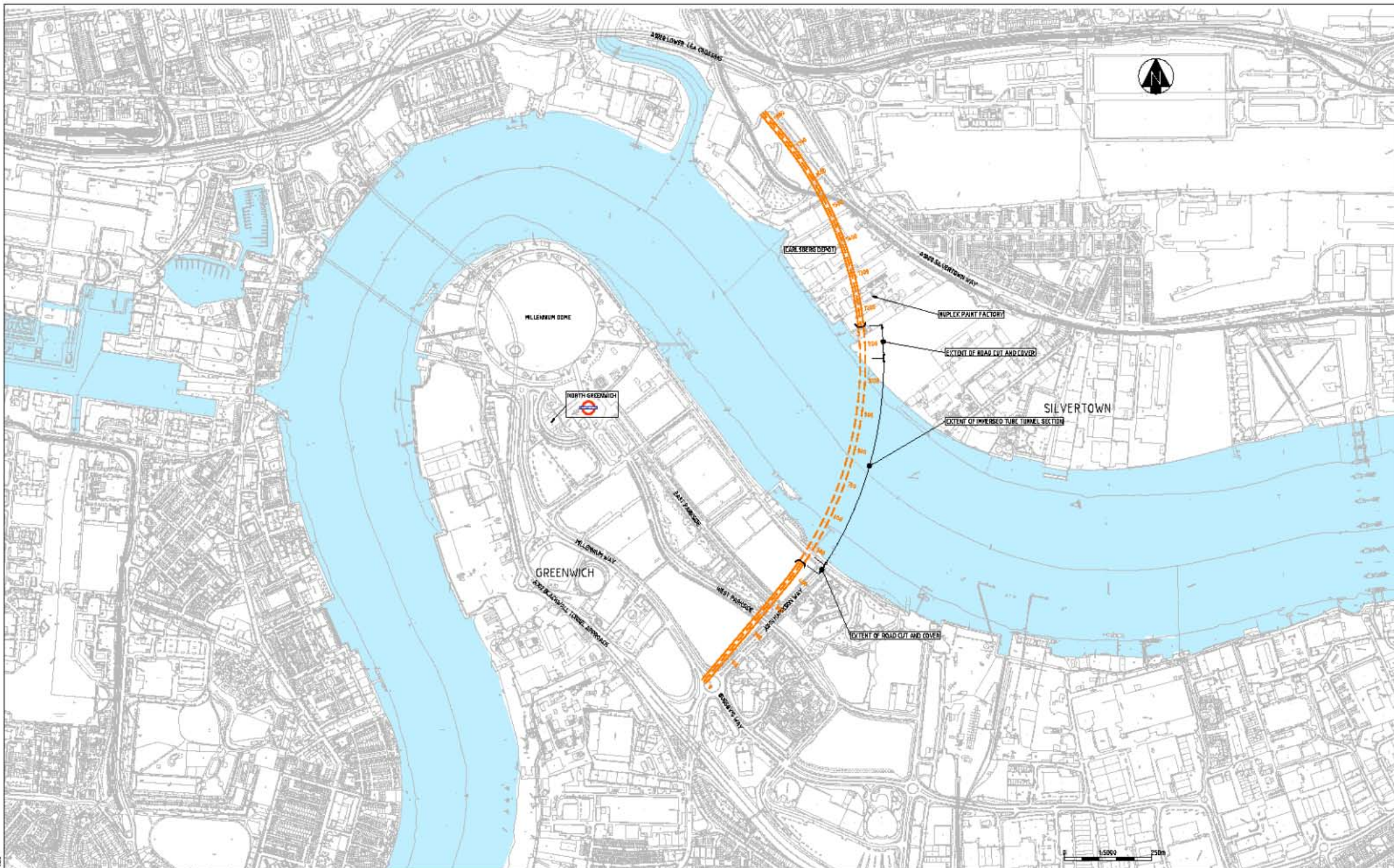

Notes

KEY

- SOUTHERN CORRIDOR ALIGNMENT A2 (SINGLE CARRIAGEWAY)
- SOUTHERN PORTAL

Issue	Description	Drawn	Auth.	Chk.	Appd.	Date
02	AMEND CUT AND COVER DIMENSIONS	RH	RS	RH	PT	16.07.09
04	CHANGE NUMBER CHANGED FROM GDD-LMTHM-GDD-02	DK	RS	RH	PT	19.06.09
07	AMENDED TO INCLUDE NORTHERN CORRIDOR	EM	RS	RH	PT	01.06.09
02	PRIOR AMENDMENT AMENDMENTS	EM	RS	RH	PT	23.04.09
01	INITIAL ISSUE	EM	RS	RH	PT	08.04.09

Client



Scale IAB
1:5000 @ A1
1:10000 @ A3

Project

NEW THAMES CROSSINGS

IMMERSED TUBE TUNNEL
SOUTHERN CORRIDOR ALIGNMENT A2
SINGLE CARRIAGEWAY
PLAN LAYOUT



HYDER CONSULTING (UK) Ltd
28 Brackenham Place
London
SW1E 5DZ
Tel: +44 (0)20 7396 6400
Fax: +44 (0)20 7396 6425

Consulting

Drawing No.
H009-LN01198-GDD

Issue
05

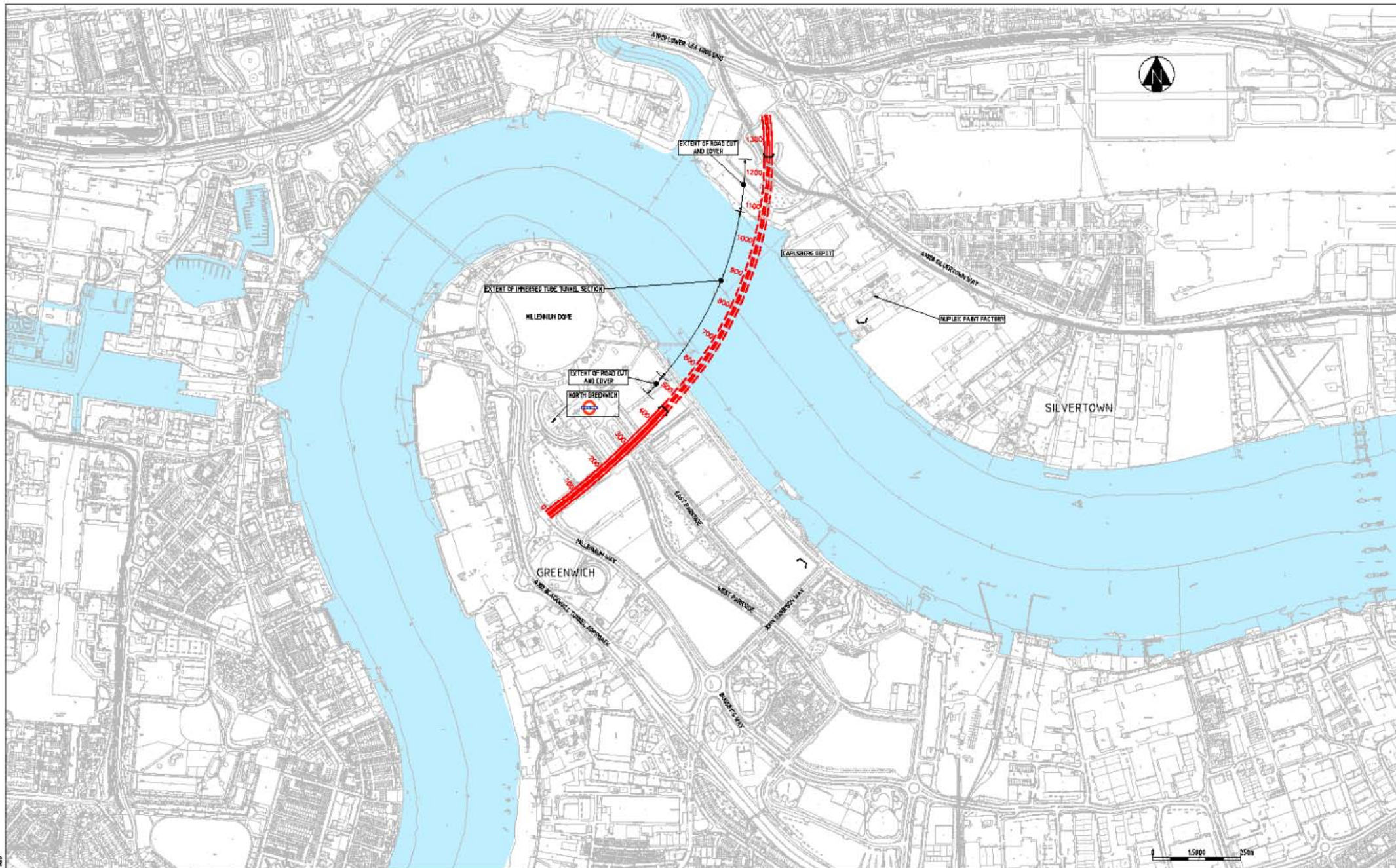

Notes

1.01

- NORTHERN CORRIDOR ALIGNMENT A1 (DUAL CARRIAGEWAY)
- NORTHERN PORTAL

Rev	Description	Drawn	Auth.	Chk.	Appd.	Date
04	AMEND CUT AND COVER CHANGES	RM	RM	RM	PT	16.02.09
03	DRAWING NUMBER CHANGES FROM BR01-LN0198-000-02	DK	RM	RM	PT	16.04.09
02	APPENDED TO INCLUDE NORTHERN CORRIDOR	EM	RM	RM	PT	05.06.09
01	INITIAL ISSUE	EM	RM	RM	PT	08.05.09

Client



Transport for London
Mindor House
42 - 50 Victoria Street
London
SW1N 0TL

Scale IAB
1:5000 @ A1
1:10000 @ A3

Client

Scale

Project

NEW THAMES CROSSINGS

Title

IMMERSED TUBE TUNNEL
NORTHERN CORRIDOR ALIGNMENT A1
DUAL CARRIAGEWAY
PLAN LAYOUT



Hyder Consulting

HYDER CONSULTING (UK) Ltd
28 Brackenham Place
London
SW1E 5DZ
Tel: +44 (0)20 7396 6400
Fax: +44 (0)20 7396 6425

Drawing No.
H011-LN01198-GDD

Issue
04

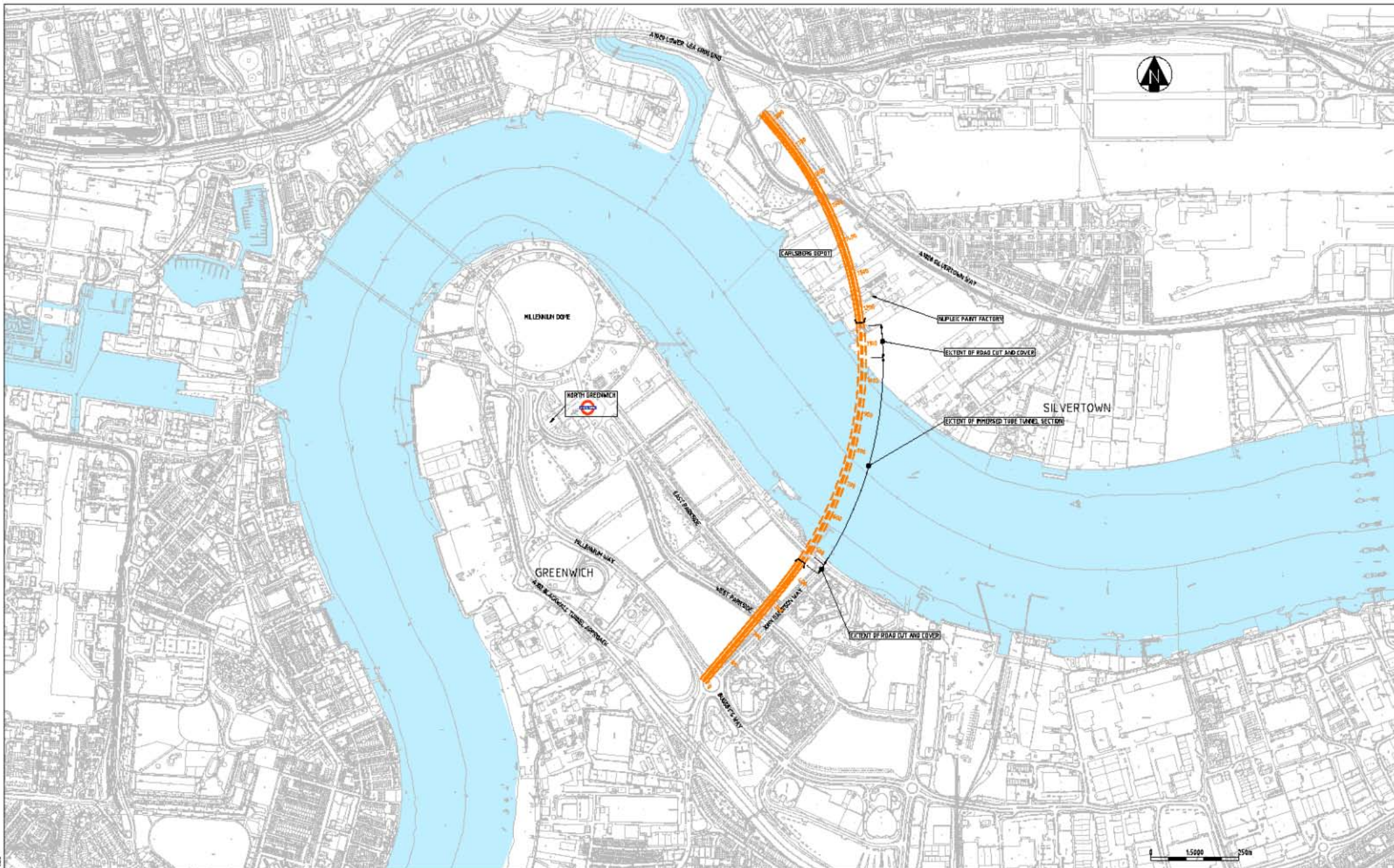

Notes

101

-  SOUTHERN CORRIDOR ALIGNMENT A2 (DUAL CARRIAGEWAY)
-  SOUTHERN PORTAL

Rev	Description	Drawn	Auth.	Chk.	Appd.	Date
04	AMEND CUT AND COVER CHANGES	RM	RM	RM	PT	10.03.09
03	DRAWING NUMBER CHANGED FROM GR-D-LN198-GDD-02	DK	RM	RM	PT	19.04.09
02	APPENDED TO INCLUDE NORTHERN CORRIDOR	EM	RM	RM	PT	25.04.09
01	INITIAL ISSUE	EM	RM	RM	PT	08.05.09

Client



Transport for London
 Windsor House
 42 - 50 Victoria Street
 London
 SW1N 9PL

Project

NEW THAMES CROSSINGS

IMMERSED TUBE TUNNEL SOUTHERN CORRIDOR ALIGNMENT A2 DUAL CARRIAGEWAY PLAN LAYOUT



HYDER CONSULTING (UK) Ltd
 28 Grosvenor Place
 London
 SW1E 5DZ
 Tel: +44 (0)20 7396 8400
 Fax: +44 (0)20 7396 8425

Consulting

Drawing No: H012-LN01198-GDD

Issue: 04

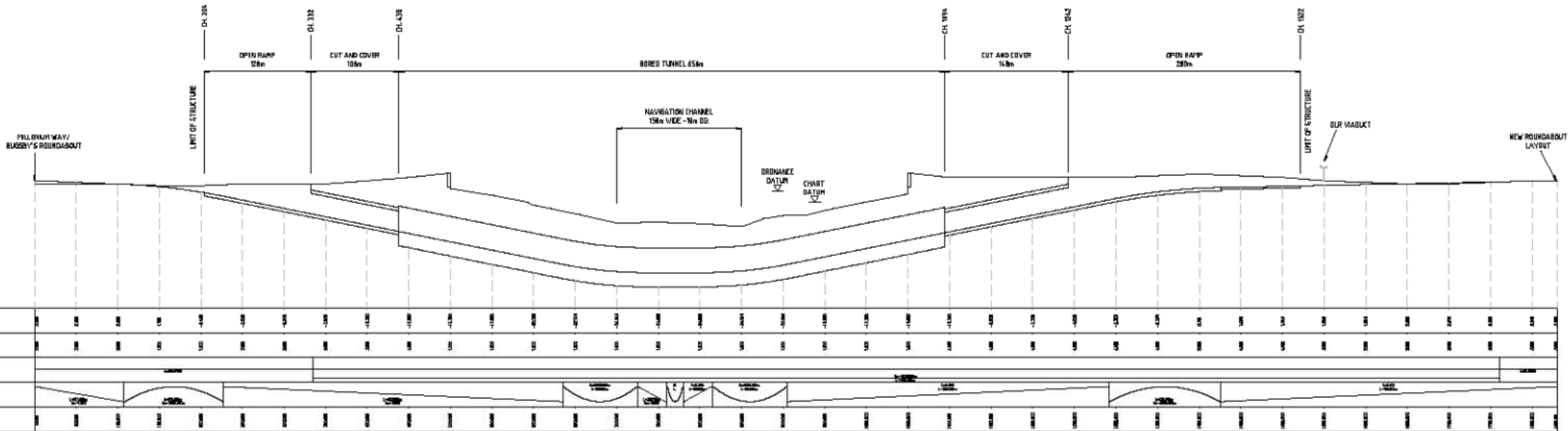

BORED TUNNEL
SOUTHERN CORRIDOR ALIGNMENT A2/2

Issue	Description	Drawn	Auth.	Chk.	Appd.	Date
03	FINAL APPROVAL/ISSUE FOR CONSTRUCTION	PH	NH	PH	PT	18.01.19
02	DRAWING NUMBER CHANGED FROM TYPE-LINING-G02-01	DK	NH	PH	PT	19.04.19
01	INITIAL ISSUE	DK	NH	PH	PT	18.04.18

Notes						

Client



Transport for London
Whodun House
42 - 50 Victoria Street
London
SW1N 0TL

Scale 1A9
V=1:425 @ A1
H=1:2500 @ A1

Datum
U=1:425 @ A3
H=1:5000 @ A3

Project

NEW THAMES CROSSINGS

Title

BORED TUNNEL
SOUTHERN CORRIDOR
ALIGNMENT A2/2
VERTICAL PROFILE



HYDER CONSULTING (UK) LTD
28 Brinkley Place
London
SW1E 5DZ
Tel: +44 (0)20 7796 6400
Fax: +44 (0)20 7796 6425

Consulting

Drawing No.
H013-LN01198-GDD

Issue
03

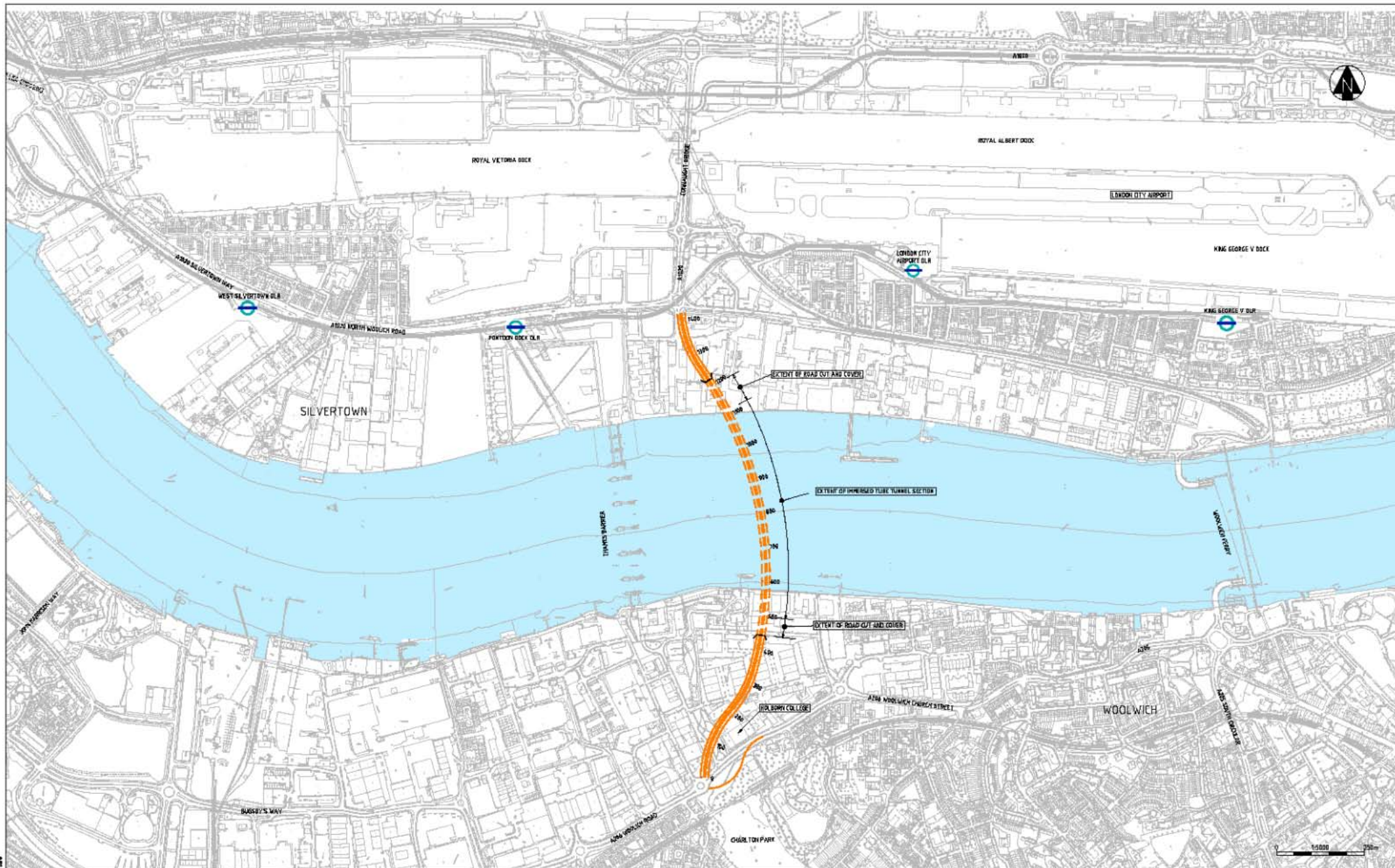

Rev	Description	Drawn	Authd	Chk	Appd	Date
03	DRAWING NUMBER CHANGED FROM E019-LN0198-GDD-02	DR	RM	RM	DT	13.16.19
02	MINOR ANNOTATION AMENDMENTS	DR	RM	RM	DT	13.16.19
01	INITIAL ISSUE	DR	RM	RM	DT	13.16.19

Notes

KEY:

- SOUTHERN CORRIDOR ALIGNMENT (DUAL CARRIAGEWAY)
- PORTAL

Client



Transport for London
Whitler House
42 - 50 Victoria Street
London
E6 9PL

Scale: IAD
1:5000 @ A1
1:10000 @ A3

Project

NEW THAMES CROSSINGS

Title

**IMMERSED TUBE TUNNEL
EAST OF THAMES BARRIER
ALIGNMENT B1 WITHOUT FLOODWALLS
PLAN LAYOUT**



HYDER CONSULTING UK Ltd
29 Grosvenor Place
London
SW1E 0DZ
Tel: +44 (0)20 7396 4400
Fax: +44 (0)20 7396 4125

Consulting

Drawing No.

H014-LN01198-GDD

Issue

03

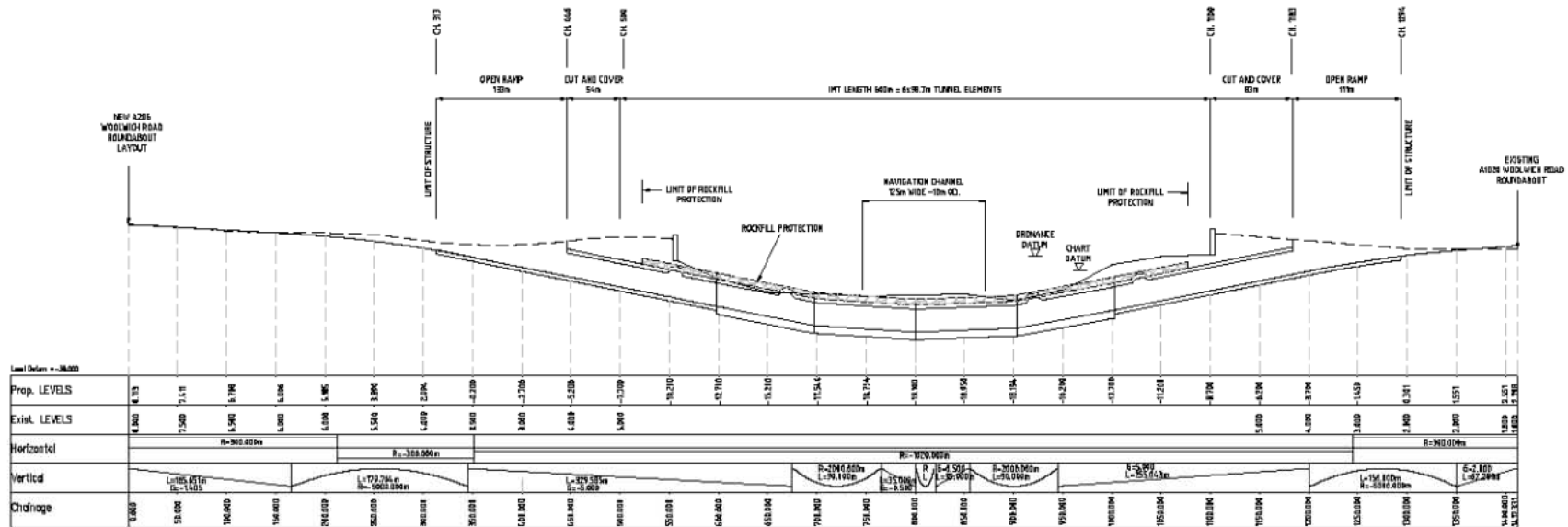

IMMERSED TUBE TUNNEL
EAST OF THAMES BARRIER ALIGNMENT B1

Rev	Issue	Description	Drawn	Auth.	Chk.	Appd.	Date
02	DRWING NUMBER CHANGED FROM T15-140198-GDD-01		DK	HR	HR	PT	18.06.19
01	INITIAL ISSUE		DK	HR	HR	PT	18.06.19

Notes

Client



Transport for London
Mindful House
42 - 50 Victoria Street
London
SW1N 8JL

Project

NEW THAMES
CROSSINGS

Title

IMMERSED TUBE TUNNEL
EAST OF THAMES BARRIER ALIGNMENT
B1 WITHOUT FLOODWALLS
VERTICAL PROFILE

Scale: (A1)
H=12500 @ A1
H=6250 @ A3

Sheet

1 of 3

Drawn

DK



HYDER CONSULTING (UK) Ltd
28 Broadwater Place
London
SW1E 5DZ
Tel: +44 (0)20 7396 6400
Fax: +44 (0)20 7396 6125

Drawing No.

H015-LN01198-GDD

Issue

02

Appendix 6

Geotechnical Information

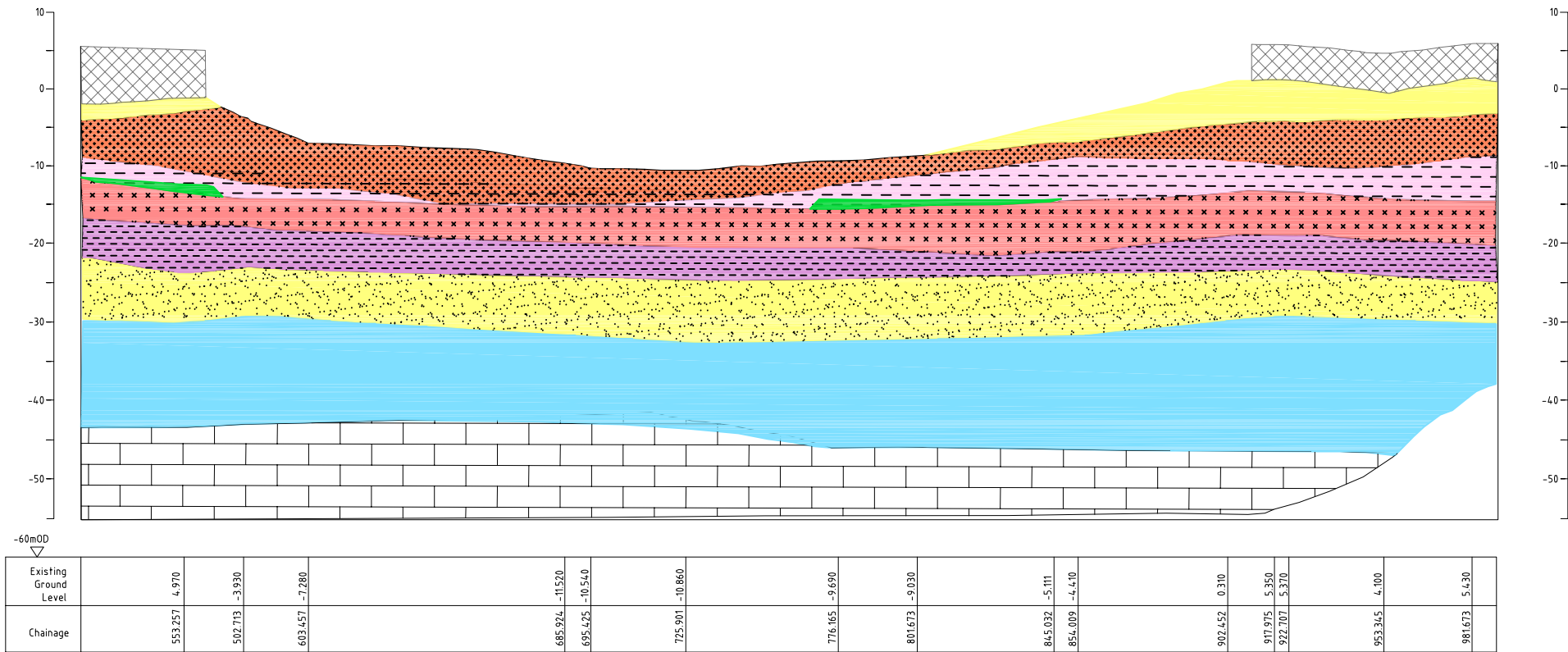

LEGEND

	MADE GROUND		WOOLWICH & READING BEDS (LAMINATED SANDS & SILTS) (LAMBETH GROUP)		THANET BEDS (NOW THANET SAND FORMATION)
	ALLUVIUM		WOOLWICH & READING BEDS (LOWER SHELLY CLAYS & LOWER MOTTLED CLAYS) (LAMBETH GROUP)		UPPER CHALK
	TERRACE DEPOSITS (SANDS & GRAVELS)		WOOLWICH & READING BEDS (PEBBLE BED AND GLAUCONITIC SAND) (LAMBETH GROUP)		
	LONDON CLAY				
	BLACKHEATH BEDS (NOW HARWICH FORMATION)				

Notes

- ALL LEVELS IN METRES ABOVE ORDANANCE DATUM
- SECTION BASED ON LONGITUDINAL GEOLOGICAL SECTION PRODUCED BY SYMONDS TRAVERS MORGAN FOR THE THIRD BLACKWALL CROSSING.
- CONDITION SHOWN ARE INDICATIVE ONLY FOR THE PROPOSED ROAD & FOOT BRIDGE AND TUNNEL CROSSINGS.

Client

Transport for London
Windsor House
42 - 50 Victoria Street
London
SW1H 0TL

Project

NEW THAMES CROSSINGS

Title

INDICATIVE LONGITUDINAL SECTION

HYDER CONSULTING (UK) Ltd
29 Bressenden Place
London
SW1E 5DZ
Tel: +44 (0)20 7316 6000
Fax: +44 (0)20 7316 6125

Scale (A1)
1:1000

Datum

Drawing No.
G009-LN01198-GDD

Issue
01

CAD Ref: A INITIAL ISSUE DK GB GB RB 06.04.09

Issue	Description	Drwn	Auth	Ckd	Appd	Date
A	INITIAL ISSUE	DK	GB	GB	RB	06.04.09

Appendix 7

Bridge Drawings

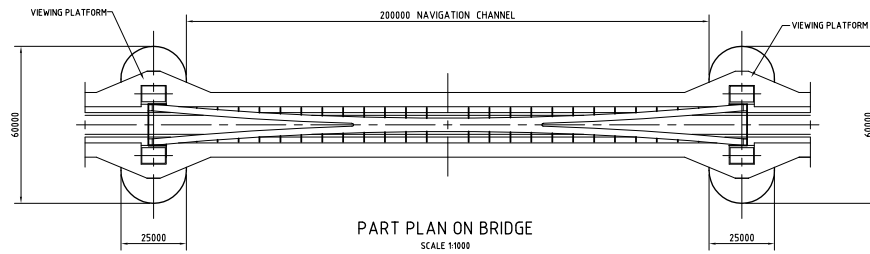
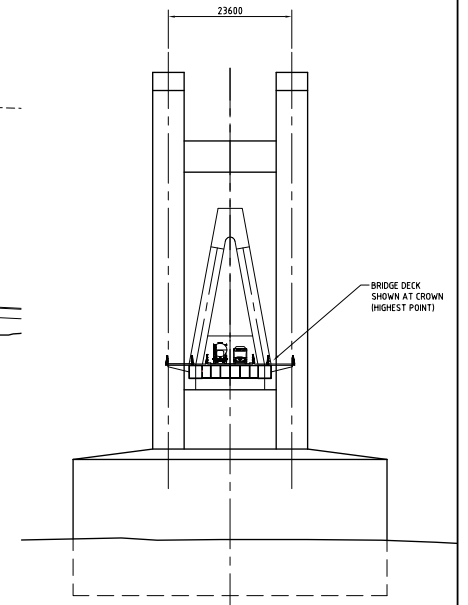
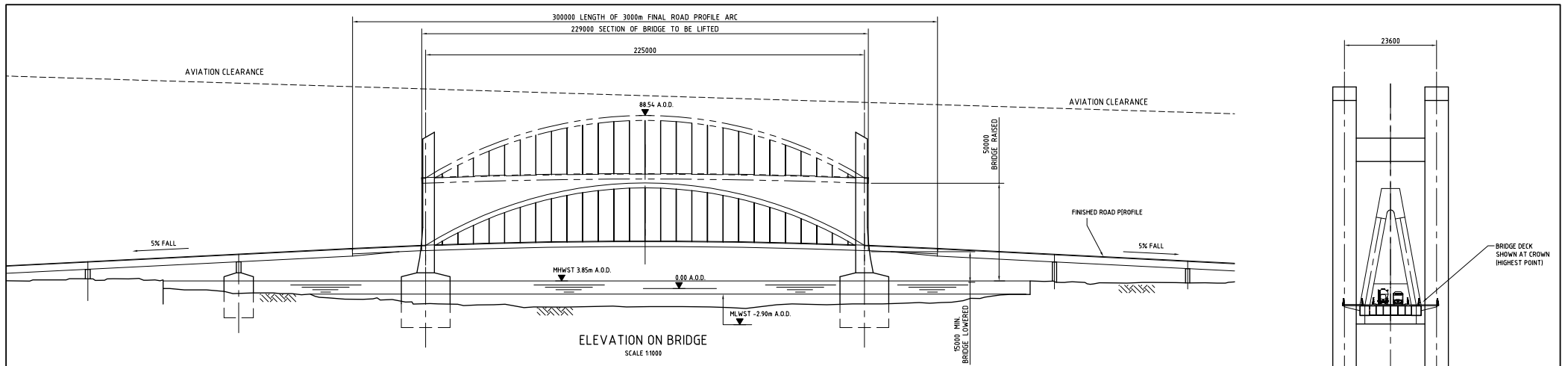

ELEVATION ON TOWER
SCALE 1:500

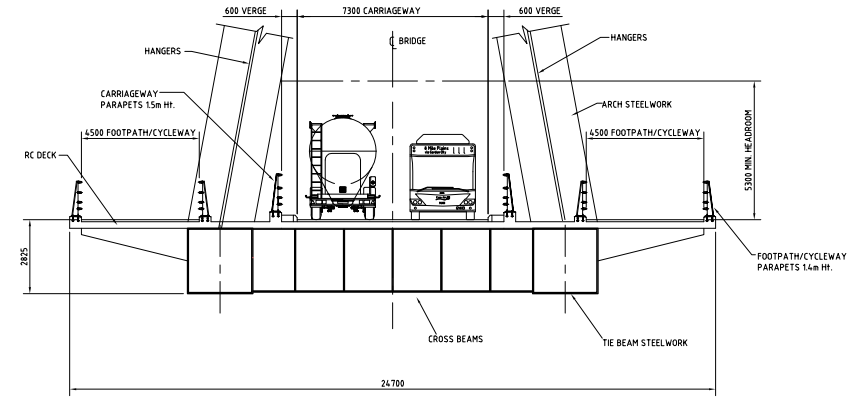
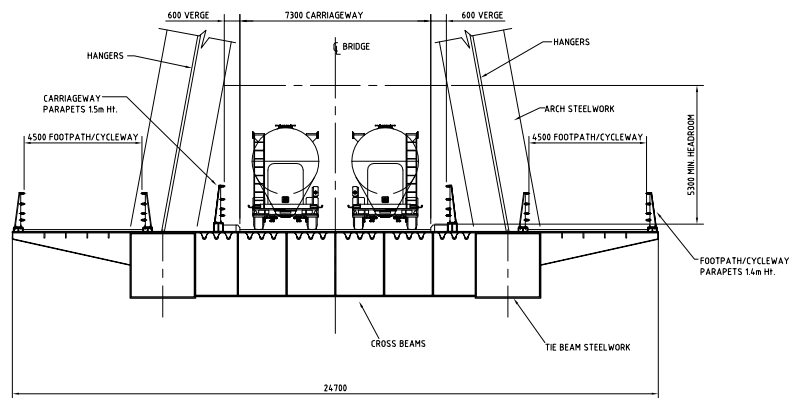

ELEVATION ON BRIDGE DECK
(STEEL DECK OPTION)
SCALE 1:100

ELEVATION ON BRIDGE DECK
(COMPOSITE DECK OPTION)
SCALE 1:100

CDR/CHK	Issue	Description	Drwn	Auth	Ckd	Appd	Date	Notes
	01	INITIAL ISSUE	PS	AM	AM	PT	06/04/09	

Client

 Transport for London
 Windsor House
 42 - 50 Victoria Street
 London
 SW1H 0TL

Scale (A1)
AS SHOWN

Datum
LOCAL

Project
NEW THAMES CROSSINGS

Title
LOW LEVEL LIFTING ROAD BRIDGE GENERAL ARRANGEMENT

 HYDER CONSULTING (UK) LTD
 29 Bressenden Place
 London
 SW1E 5DZ
 Tel: +44 (0)20 7316 6000
 Fax: +44 (0)20 7316 6125

Drawing No.
S001-LN01198-NED

Issue
01

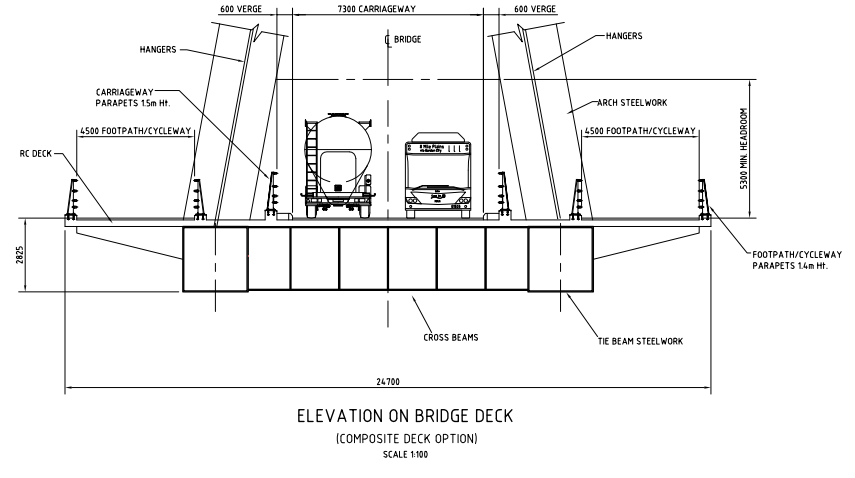
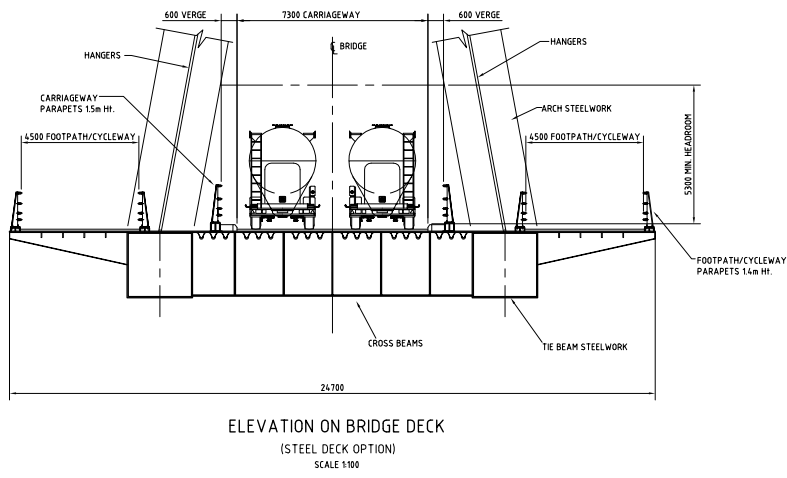
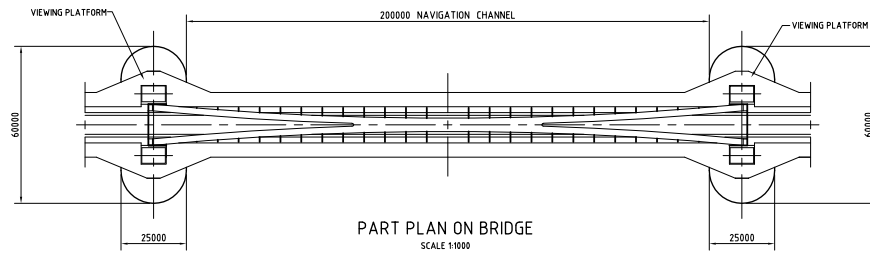
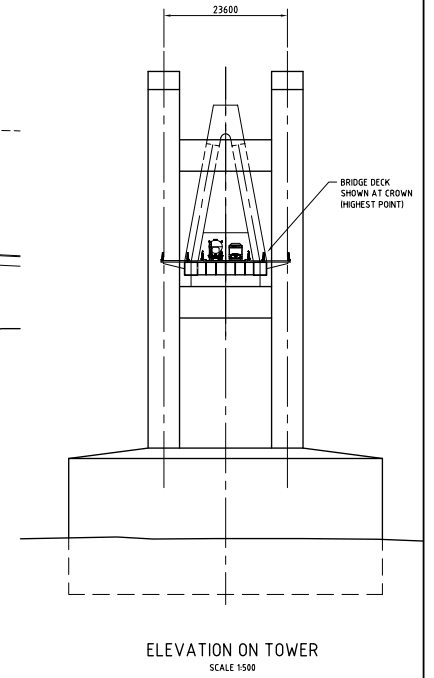
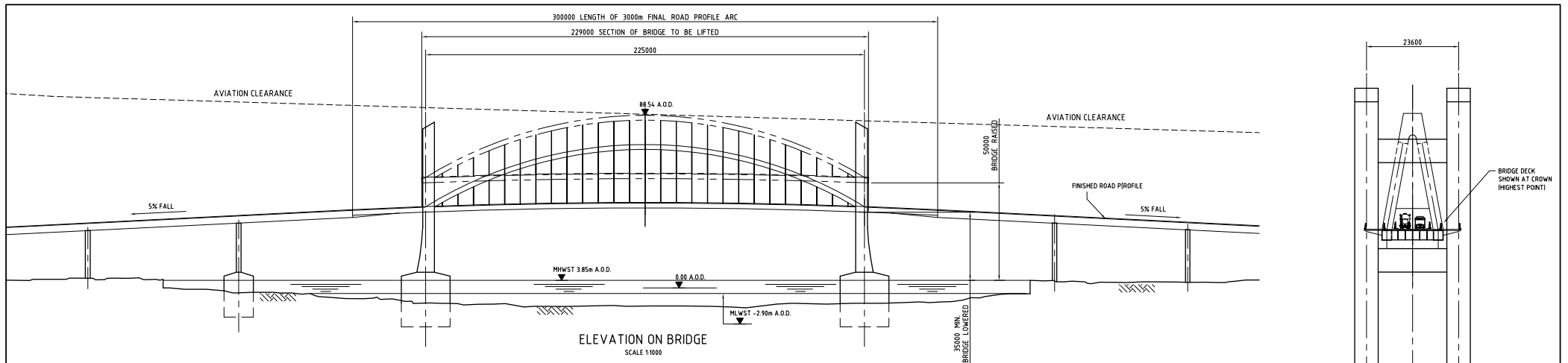

Rev	Date	Description	Drwn	Auth	Ckd	Appd	Date
01		INITIAL ISSUE	PS/BN	AM	AM	PT	06/04/09

Notes

Client

 Transport for London
 Windsor House
 42 - 50 Victoria Street
 London
 SW1H 0TL
 Scale (A1)
 AS SHOWN

Project
NEW THAMES CROSSINGS
 Title
MID LEVEL LIFTING ROAD BRIDGE GENERAL ARRANGEMENT
 Datum
 LOCAL

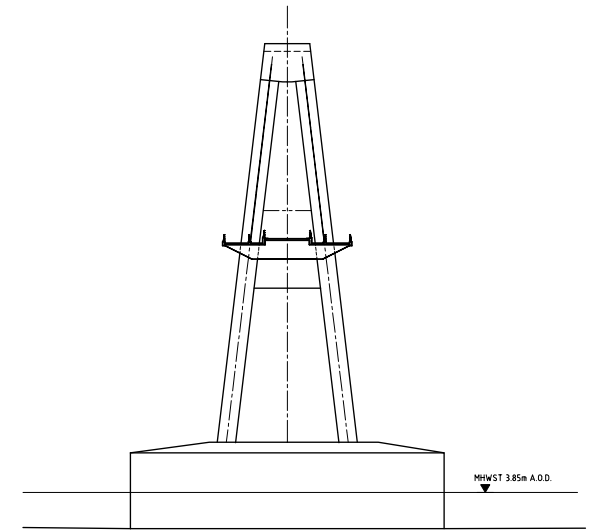
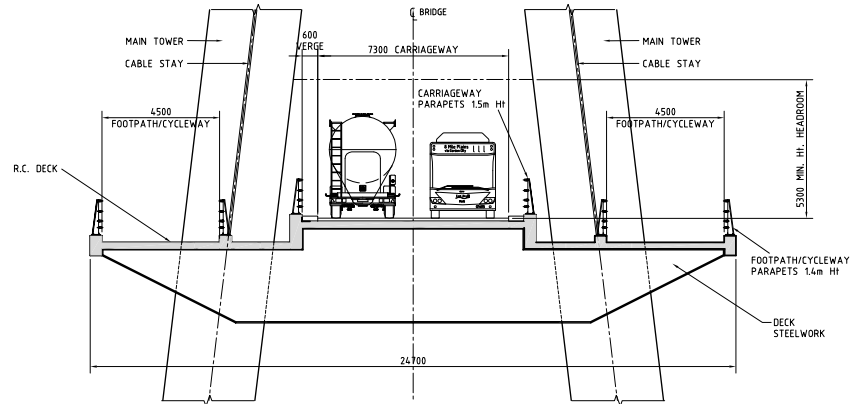
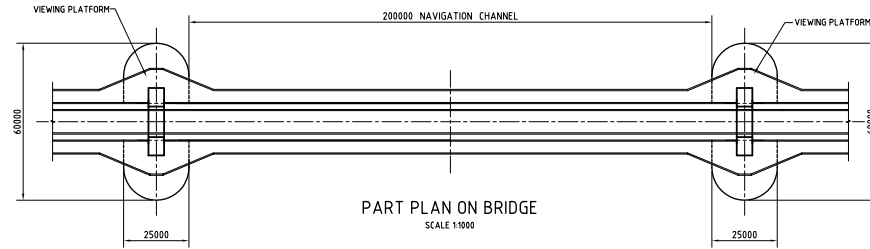
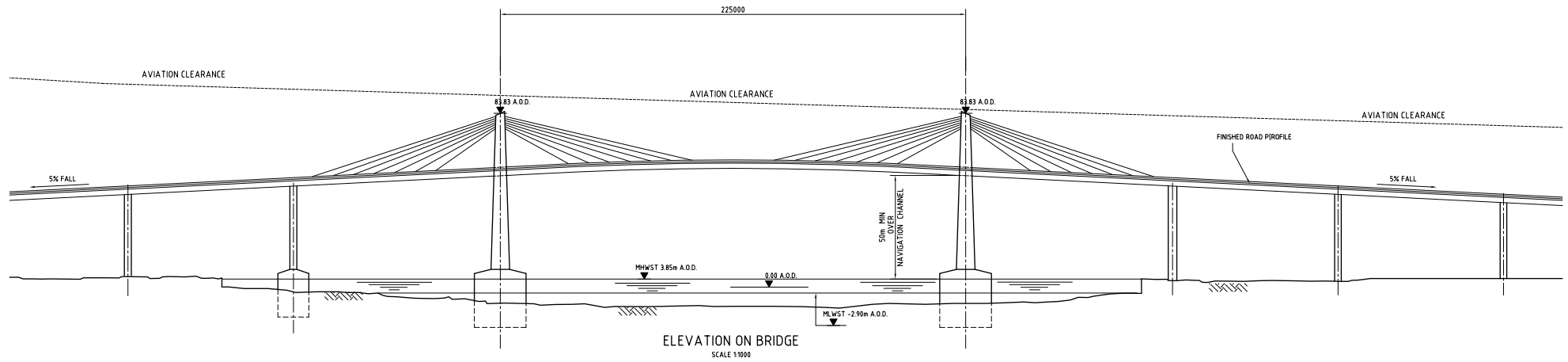
 HYDER CONSULTING (UK) LTD
 29 Bressenden Place
 London
 SW1E 5DZ
 Tel: +44 (0)20 7316 6000
 Fax: +44 (0)20 7316 6125
 Drawing No.
S002-LN01198-NED
 Issue
01



Rev. Date

Issue	Description	Drwn	Auth	Ckd	Appd	Date
01	INITIAL ISSUE	BN	AM	AM	PT	06/04/09

Notes

Client



Transport for London
Windsor House
42 - 50 Victoria Street
London
SW1H 0TL

Scale (A1)

AS SHOWN

Datum

LOCAL

Project

NEW THAMES
CROSSINGS

Title
HIGH LEVEL FIXED
ROAD BRIDGE
GENERAL ARRANGEMENT



HYDER CONSULTING (UK) LTD
29 Bressenden Place
London
SW1E 5DZ
Tel: +44 (0)20 7316 6000
Fax: +44 (0)20 7316 6125

Drawing No.

S003-LN01198-NED

Issue

01

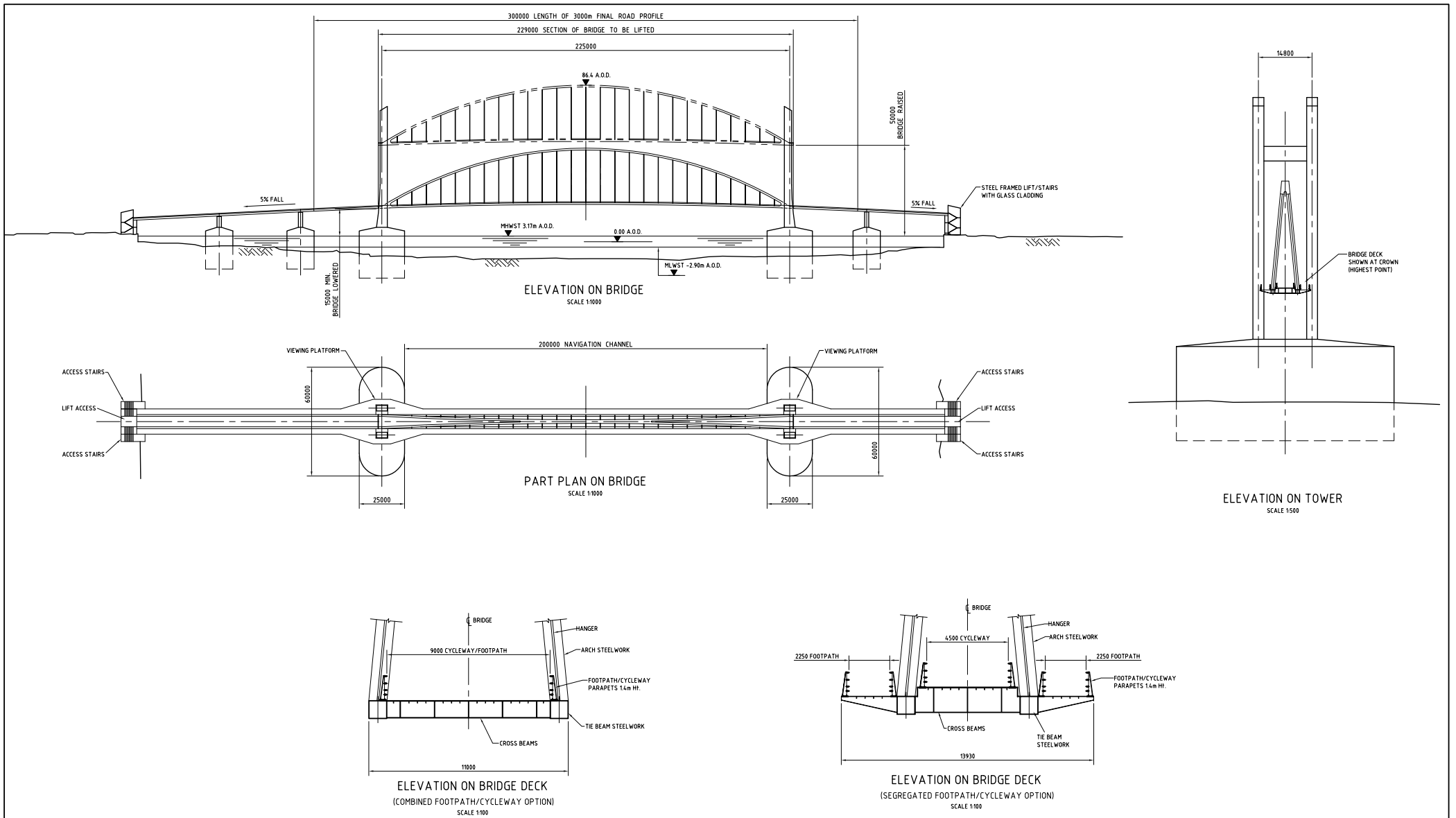

Proj. Date

Issue	Description	Drwn.	Auth.	Ckd.	Appd.	Date
01	INITIAL ISSUE	PS	AM	AM	PT	06/04/09

Notes						

Client



Transport for London
Windsor House
42 - 50 Victoria Street
London
SW1H 0TL

Scale (A1)
AS SHOWN

Datum
LOCAL

Project

NEW THAMES CROSSINGS

Title
**LOW LEVEL LIFTING
FOOTPATH/CYCLEWAY BRIDGE
GENERAL ARRANGEMENT**



HYDER CONSULTING (UK) LTD
29 Bressenden Place
London
SW1E 5DZ
Tel: +44 (0)20 7316 6000
Fax: +44 (0)20 7316 6125

Consulting

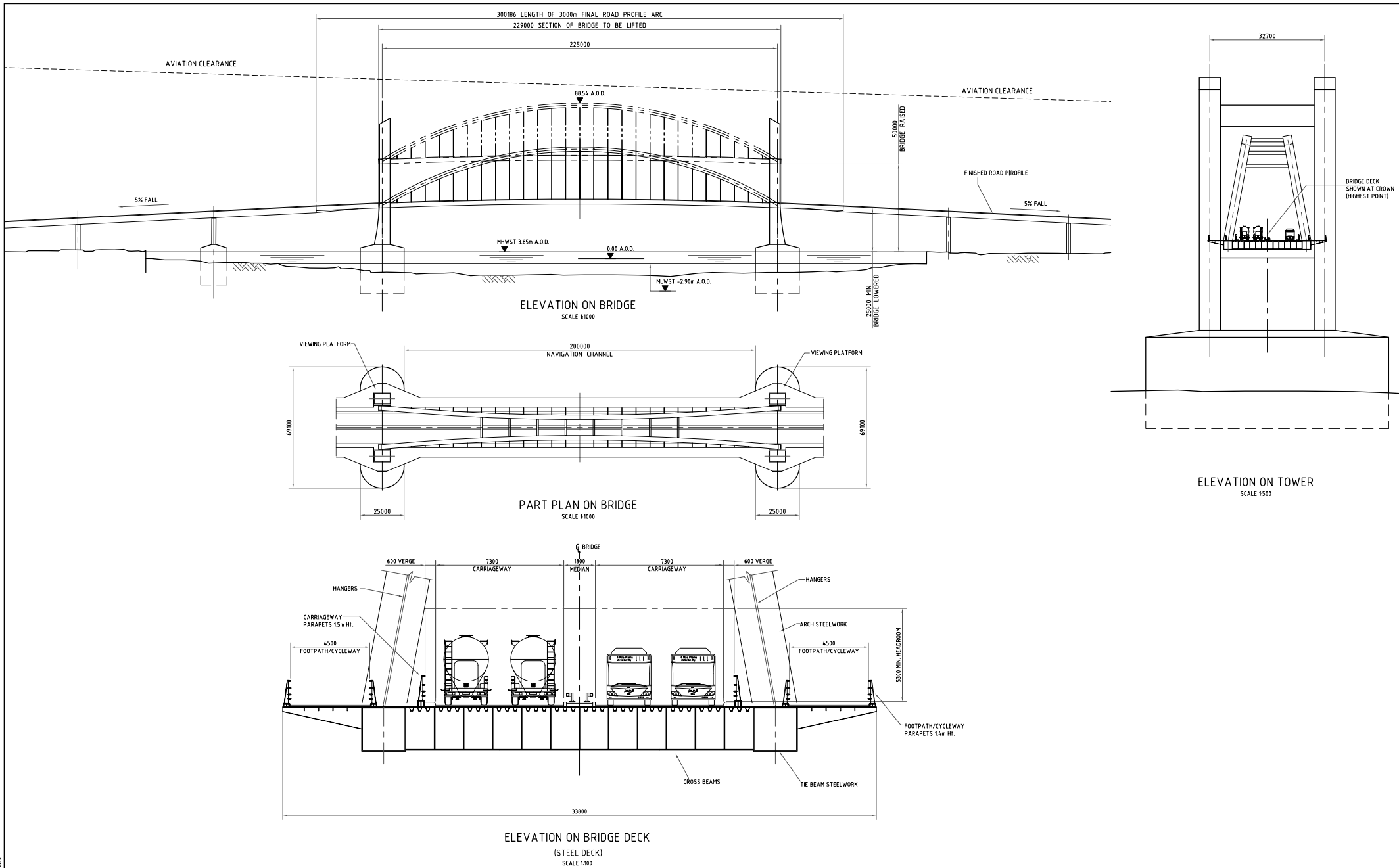

Drawing No.
S004-LN01198-NED

Issue
01



Notes

01	INITIAL ISSUE	PS	AM	AM	PT	25/05/09
Issue	Description	Drwn	Auth	Ckd	Appd	Date

		Client Transport for London Windsor House 42 - 50 Victoria Street London SW1H 0TL	Project NEW THAMES CROSSINGS		HYDER CONSULTING (UK) LTD 29 Bressenden Place London SW1E 5DZ Tel: +44 (0)20 7316 6000 Fax: +44 (0)20 7316 6125
Scale (A1) AS SHOWN	Datum LOCAL	Title DUAL CARRIAGEWAY LIFTING ROAD BRIDGE GENERAL ARRANGEMENT	Drawing No. S005-LN01198-NED		

Plot Date: _____

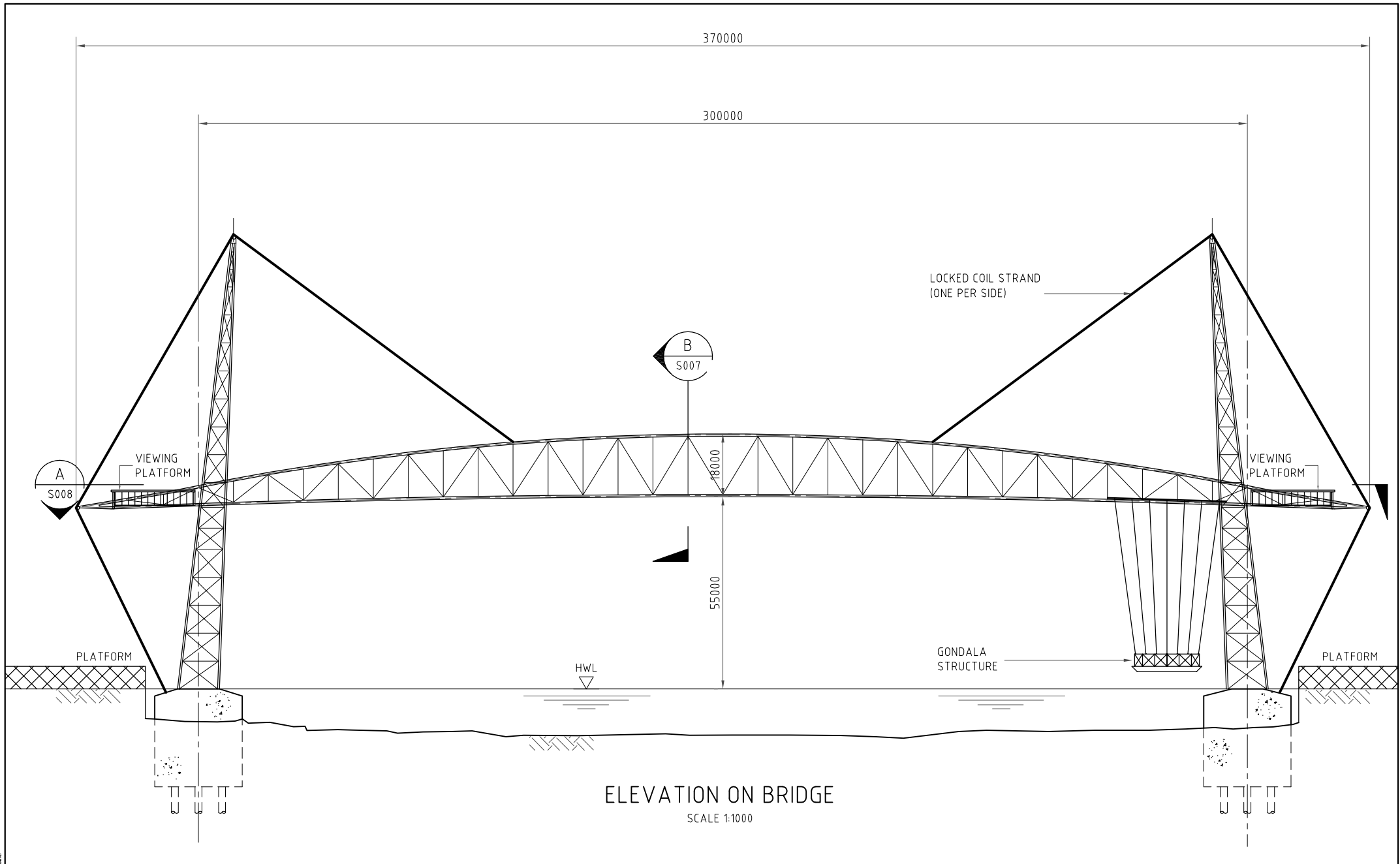

CADD File

Issue	Description	Drwn.	Auth.	Ckd.	Appd.	Date
01	INITIAL ISSUE	YT	PB	PB	PT	06/07/09

Notes	

Client



Transport for London
Windsor House
42 - 50 Victoria Street
London
SW1H 0TL

Scale (A1)

AS SHOWN

Project

NEW THAMES CROSSINGS

Title

CABLE-STAYED TRANSPORTER BRIDGE GENERAL ARRANGEMENT



HYDER CONSULTING (UK) Ltd
29 Brassenden Place
London
SW1E 5DZ
Tel: +44 (0)20 7316 6000
Fax: +44 (0)20 7316 6125

Consulting

Drawing No.

S006-LN01198-NED-PB 01

Issue

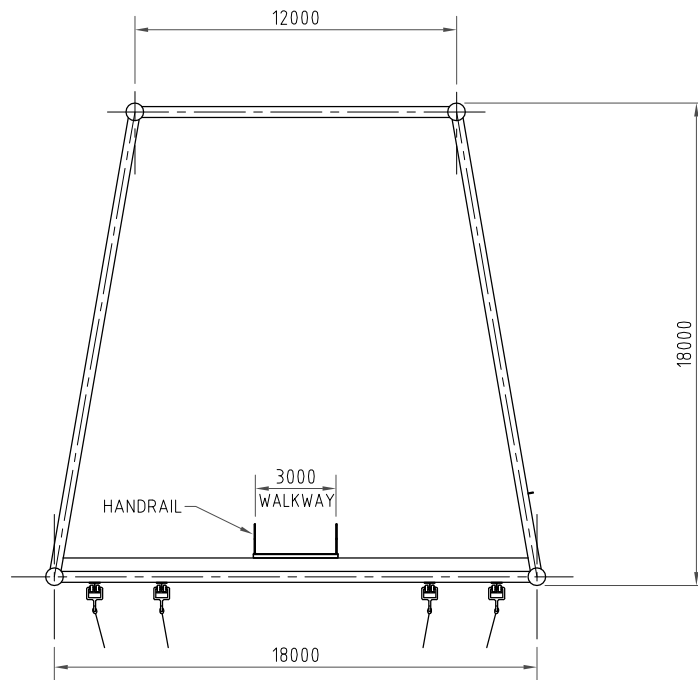

VIEW ON B-B
SCALE 1:100

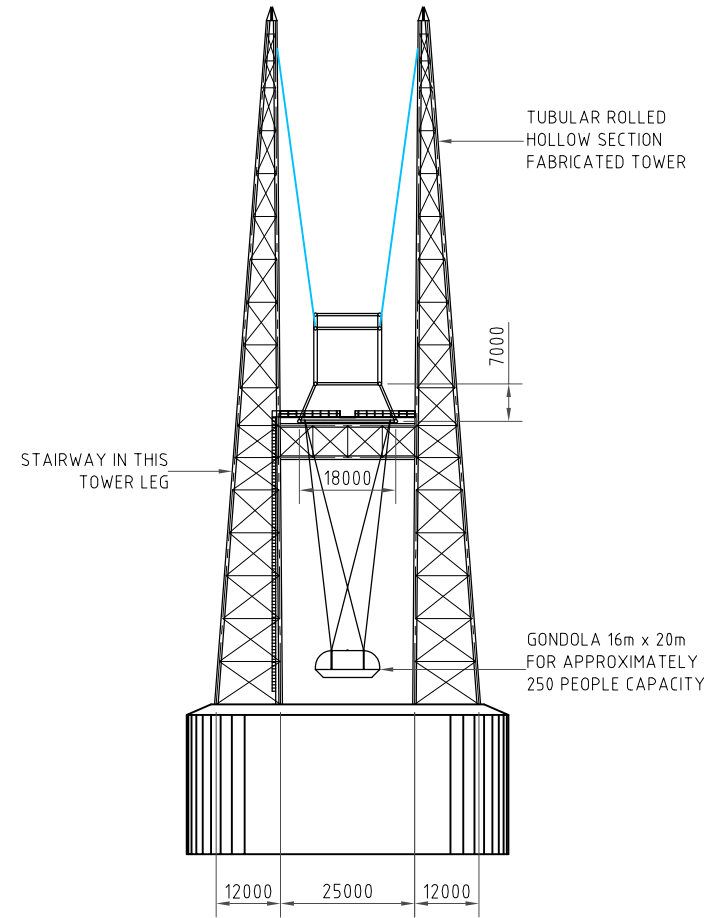

VIEW ON C-C
SCALE 1:1000

CADD Ref: Part Date

Issue	Description	Drawn	Auth.	Ckd.	Appd.	Date
01	INITIAL ISSUE	YT	PB	PT		08/07/09

Notes	

 <p>Client Transport for London Windsor House 42 - 50 Victoria Street London SW1H 0TL</p>	
Scale (A1)	Datum
AS SHOWN	LOCAL

<p>Project NEW THAMES CROSSINGS</p>	
<p>Title CABLE-STAYED TRANSPORTER BRIDGE SECTIONS</p>	

 <p>HYDER CONSULTING (UK) Ltd 29 Grosvenor Place London SW1E 5DZ Tel: +44 (0)20 7316 6000 Fax: +44 (0)20 7316 6125</p>	
Drawing No.	Issue
S007-LN01198-NED-PB	01

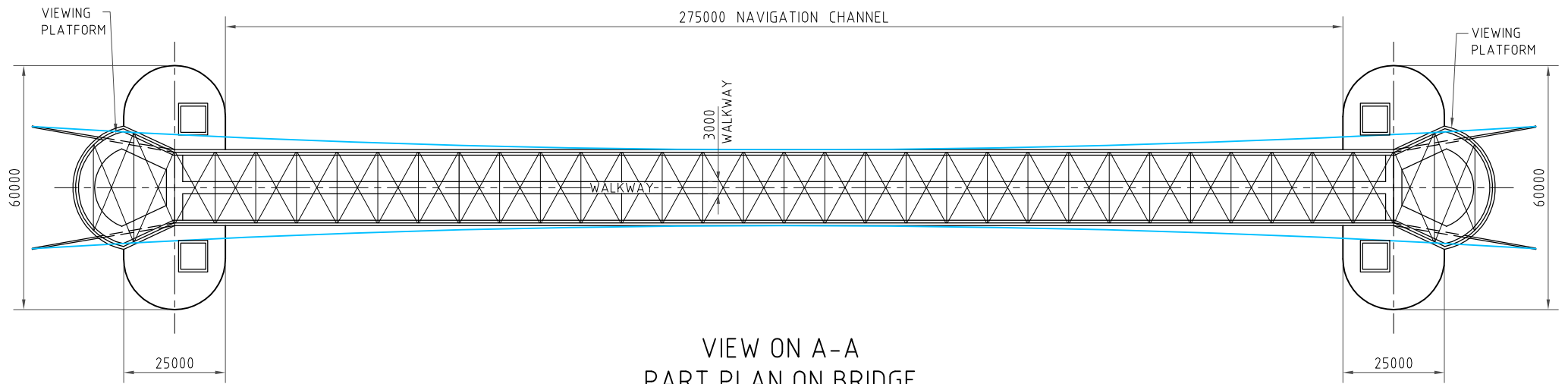

VIEW ON A-A
PART PLAN ON BRIDGE
SCALE 1:1000

CADD Ref: Part Date

Issue	Description	Drwn	Auth	Ckd	Appd	Date
01	INITIAL ISSUE	YT	PB	PB	PT	06/07/09

Notes	

 Transport for London Windsor House 42 - 50 Victoria Street London SW1H 0TL	
Scale (A1)	Datum
AS SHOWN	LOCAL

NEW THAMES CROSSINGS
CABLE-STAYED TRANSPORTER BRIDGE PLAN

 HYDER CONSULTING (UK) Ltd 29 Brassenden Place London SW1E 5DZ Tel: +44 (0)20 7316 6000 Fax: +44 (0)20 7316 6125	Drawing No: S008-LN01198-NED-PB 01	Issue
--	---	-------

Appendix 8

Tunnel Drawings

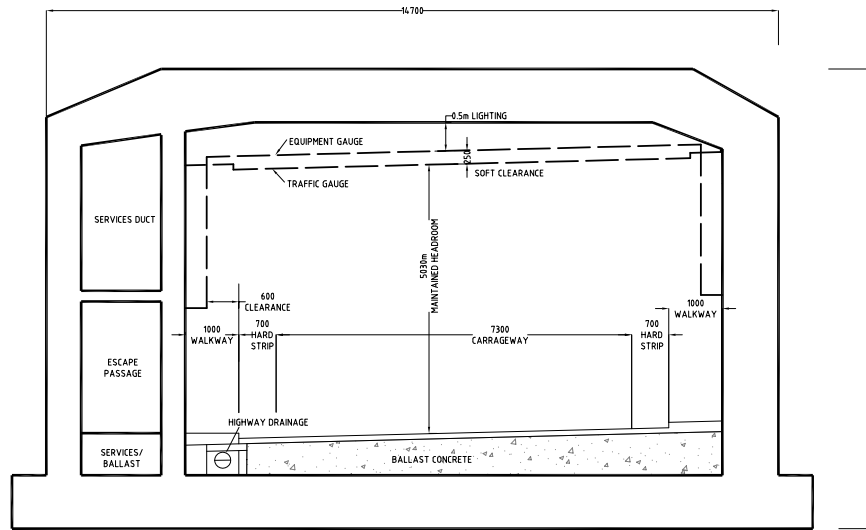

TYPICAL CROSS SECTION
(SINGLE 2-LANE IMMERSED TUNNEL)

SCALE 1:50 @ A1

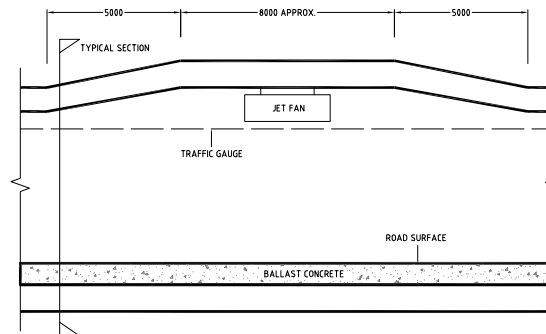

RAISED NICHE TO ACCOMMODATE JET FAN

SCALE 1:100 @ A1

Notes

Client



Transport for London
Windsor House
42 - 50 Victoria Street
London
SW1H 0TL

Project

NEW THAMES
CROSSINGS

Title

TYPICAL CROSS SECTION
SINGLE 2-LANE
IMMERSED TUNNEL



HYDER CONSULTING (UK) LTD
29 Bressenden Place
London
SW1E 5DZ
Tel: +44 (0)20 7316 6000
Fax: +44 (0)20 7316 6125

Scale (A1)

AS SHOWN

Datum

Drawing No.

T001-LN01198-GDD

Issue

01

CMB:REV

Issue	Description	Drwn	Auth	Ckd	Appd	Date
01	INITIAL ISSUE	DK	RH	RH	PT	10.06.09

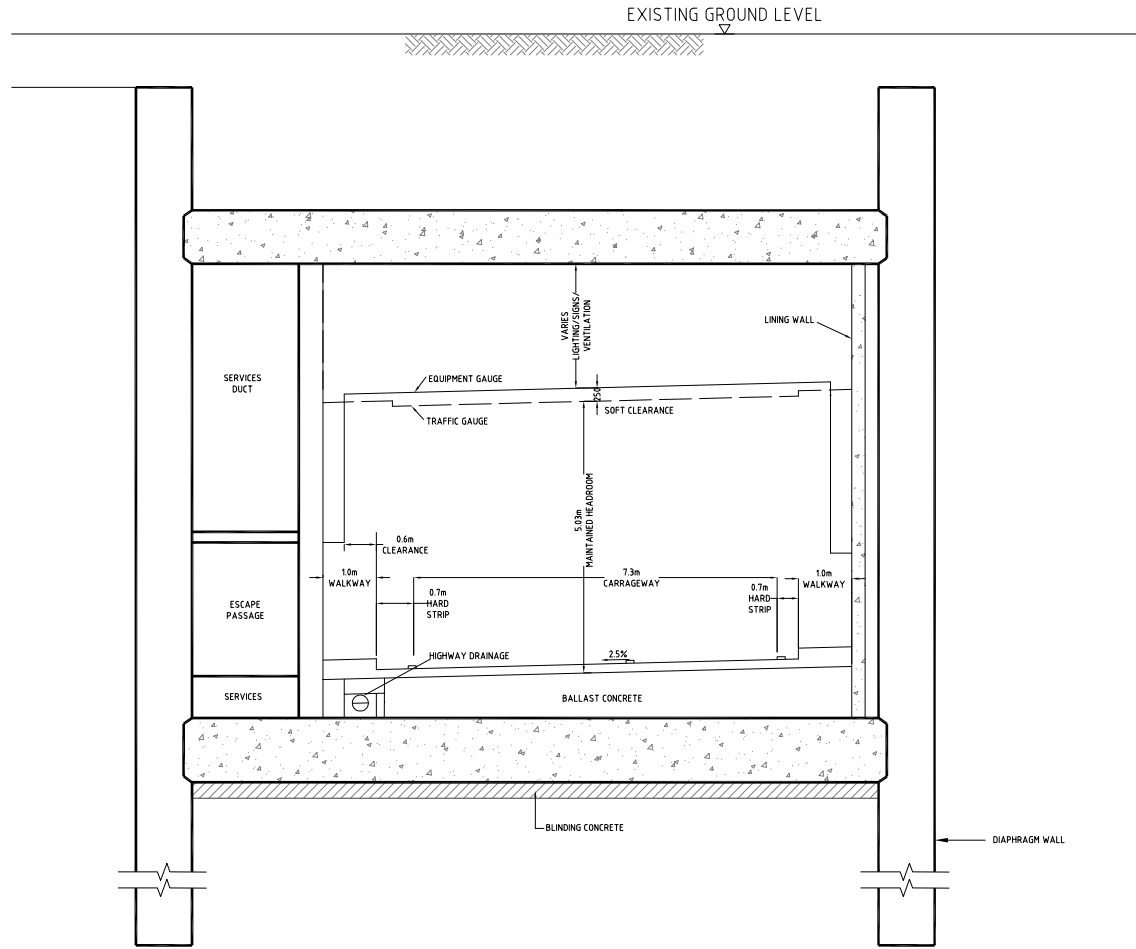

TYPICAL SECTION THROUGH CUT AND COVER
APPROACH TUNNEL

SCALE 1:50

CADD Ref: 10.06.09

Issue	Description	Drwn	Auth	Ckd	Appd	Date
01	INITIAL ISSUE	DK	RH	RH	PT	10.06.09

Notes	

Client



Transport for London
Windsor House
42 - 50 Victoria Street
London
SW1H 0TL

Scale (A1) 1:50 @ A1
1:100 @ A3

Datum

Project

NEW THAMES
CROSSINGS

Title

TYPICAL CROSS SECTION
CUT AND COVER
APPROACH TUNNEL



HYDER CONSULTING (UK) LTD
29 Bressenden Place
London
SW1E 5DZ
Tel: +44 (0)20 7316 6000
Fax: +44 (0)20 7316 6125

Consulting

Drawing No. T002-LN01198-GDD

Issue 01

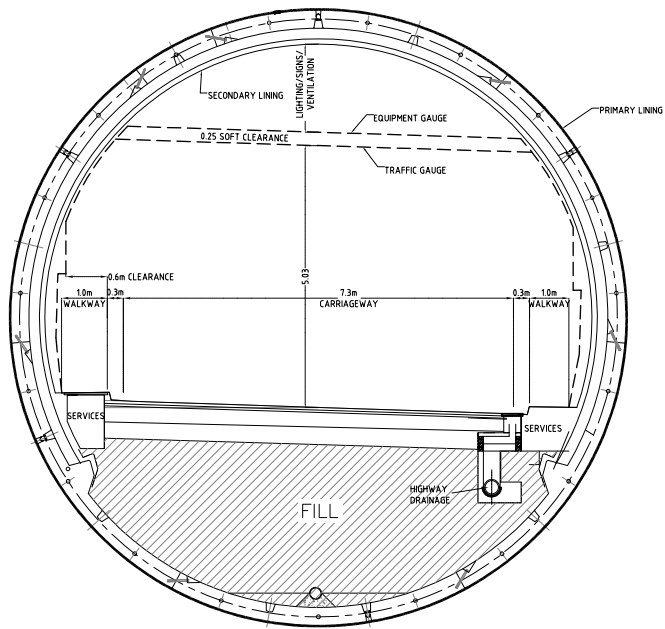

TYPICAL CROSS SECTION
BORED TUNNEL

Plot Date:

01	INITIAL ISSUE	DK	RH	RH	PT	10.06.09
Issue	Description	Drwn	Auth	Ckd	Appd	Date

Notes	

 Transport for London Windsor House 42 - 50 Victoria Street London SW1H 0TL	
Scale (A1)	1:50 @ A1 1:100 @ A3
Datum	

Client	Project
NEW THAMES CROSSINGS	
Title	TYPICAL CROSS SECTION BORED TUNNEL

 Consulting	HYDER CONSULTING (UK) LTD 29 Bressenden Place London SW1E 5DZ Tel: +44 (0)20 7316 6000 Fax: +44 (0)20 7316 6125
Drawing No.	Issue
T004-LN01198-GDD	01

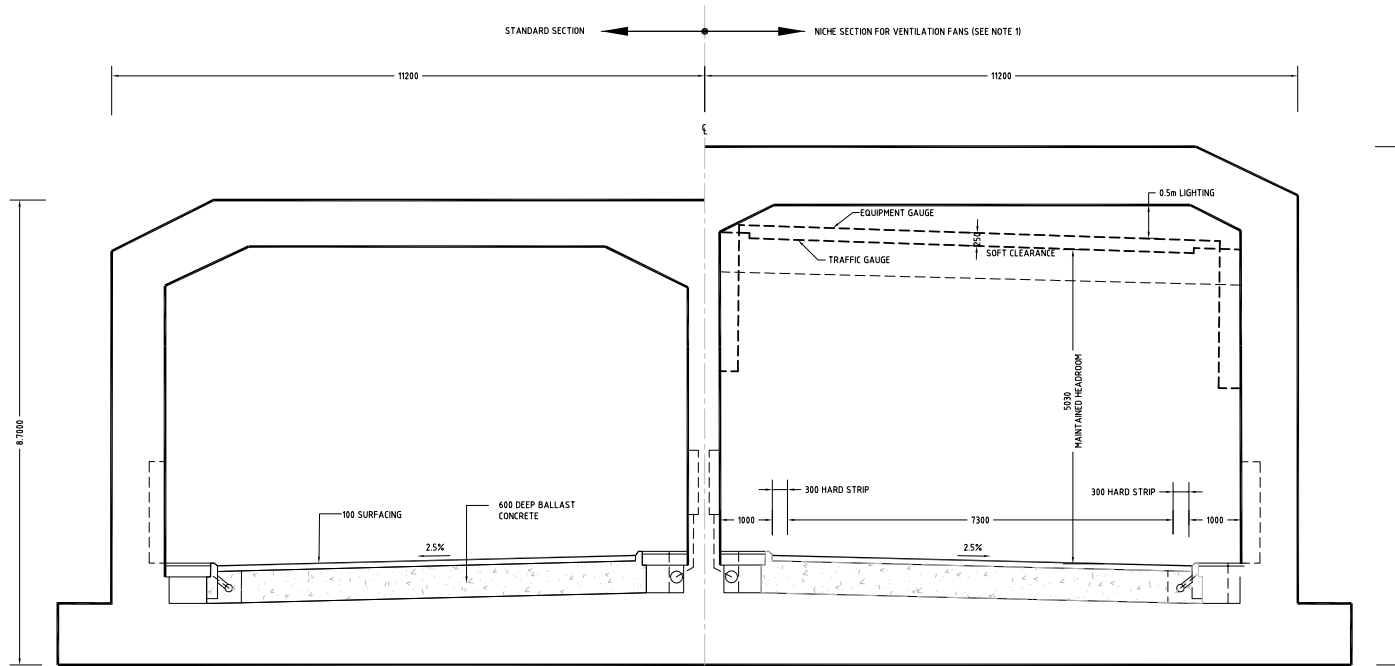

TYPICAL CROSS SECTION
 (DUAL 2-LANE IMMERSSED TUNNEL)
 SCALE 1:50 @ A1

Notes

1- FOR LAYOUT OF NICHE SECTION REFER DRG NO. T001-LN01198-GDD

01	INITIAL ISSUE	DK	RH	RH	PT	10.06.09
Issue	Description	Drwn	Auth	Ckd	Appd	Date

Client

STREETS
 Transport for London
 Windsor House
 42 - 50 Victoria Street
 London
 SW1H 0TL

Scale (A1)
 H=1:50 @ A1
 V=1:50 @ A1

H=1:100 @ A3
 V=1:100 @ A3

Datum

Project

NEW THAMES
 CROSSINGS

Title

TUNNEL CROSS SECTION
 DUAL 2-LANE
 IMMERSSED TUNNEL



HYDER CONSULTING (UK) LTD
 29 Bressenden Place
 London
 SW1E 5DZ
 Tel: +44 (0)20 7316 6000
 Fax: +44 (0)20 7316 6125

Drawing No.

T008-LN01198-GDD

Issue

01